

ARIZONA DEPARTMENT OF TRANSPORTATION

REPORT NUMBER: FHWA/AZ 83/184

# SCOUR AT SILL STRUCTURES

**Prepared by:**

Emmett M. Laursen  
Matthew W. Flick  
Arizona Transportation & Traffic Institute  
College of Engineering  
The University of Arizona  
Tucson, Arizona 85721

**NOVEMBER 1983**

**Prepared for**

Arizona Department of Transportation  
206 South 17th Avenue  
Phoenix, Arizona 85007

and

The U.S. Department of Transportation  
Federal Highway Administration  
Arizona Division

The contents of this report reflect the views of the authors who are responsible for the facts and the accuracy of the data presented herein. The contents do not necessarily reflect the official views or policies of the Arizona Department of Transportation or the Federal Highways Administration. This report does not constitute a standard, specification, or regulation. Trade or manufacturer's names which may appear herein are cited only because they are considered assential to the objectives of the report. The U. S. Government and the State of Arizona do not endorse products or manufacturers.

1. Report No. FHWA/AZ-83/184-3		2. Government Accession No.		3. Recipient's Catalog No.	
4. Title and Subtitle PREDICTING SCOUR AT BRIDGES: QUESTIONS NOT FULLY ANSWERED -- SCOUR AT SILL STRUCTURES				5. Report Date November 1983	
				6. Performing Organization Code	
7. Author(s) Emmett M. Laursen and Matthew W. Flick				8. Performing Organization Report No. ATTI-83-6	
9. Performing Organization Name and Address Arizona Transportation & Traffic Institute College of Engineering University of Arizona Tucson, Arizona 85721				10. Work Unit No. (TRAIS)	
				11. Contract or Grant No. HPR-1-19(184)	
12. Sponsoring Agency Name and Address Arizona Department of Transportation 206 South 17th Avenue Phoenix, Arizona 85007				13. Type of Report and Period Covered Final Report November 1983	
				14. Sponsoring Agency Code	
15. Supplementary Notes					
16. Abstract <p>The scour at the toe of a vertical wall and at the toe of a sloping sill were investigated experimentally and analytically. Approximate relations for predicting the ratio of the scour depth to the (energy) critical depth were obtained for the two geometries. For the vertical wall, the sediment scoured out left in suspension, and the parameters needed to describe the scour phenomenon were the ratio of the (energy) critical velocity to the fall velocity and the drop in water surface in ratio to the critical depth. For the sloping sill, which is the recommended geometry, the sediment scoured out left as bed load, and the parameters needed to describe the scour phenomenon were the critical depth/sediment size ratio and the ratio of the size of the riprap protecting the sill slope to the critical depth.</p> <p>Degradation of the stream bed is likely to be the reason for constructing sill structures. A discussion of the degradation phenomena is included to serve as a guide to evaluating to what extent degradation might be a threat to a bridge, culvert or highway.</p>					
17. Key Words scour, drop structures, sills, bridge foundations			18. Distribution Statement		
19. Security Classif. (of this report) UNCLASSIFIED		20. Security Classif. (of this page) UNCLASSIFIED		21. No. of Pages 69	22. Price

## ACKNOWLEDGMENTS

This report was prepared as a final report for Project HRP 1-19(184), "Predicting Scour at Bridges: Questions Not Fully Answered -- Scour at Sill Structures". This research was conducted by the Arizona Transportation and Traffic Institute, College of Engineering, University of Arizona, for the Arizona Department of Transportation and the U. S. Department of Transportation, Federal Highway Administration.

FINAL REPORT  
PREDICTING SCOUR AT BRIDGES: QUESTIONS NOT FULLY ANSWERED  

---

SCOUR AT SILL STRUCTURES

TABLE OF CONTENTS

	<u>Page Number</u>
PROLOGUE.....	1
PART I. SCOUR AT THE TOE OF A VERTICAL WALL	
THE QUESTION.....	3
FLOW AND SCOUR PATTERNS EXPECTED.....	5
THE EXPERIMENTS.....	9
APPLICATION.....	17
PART II. SCOUR AT THE TOE OF A SLOPING SILL	
THE QUESTION.....	21
FLOW AND SCOUR PATTERNS EXPECTED.....	23
THE EXPERIMENTS.....	29
APPLICATION.....	37
PART III. SILL STRUCTURES AS REMEDIAL MEASURES	
THE PROBLEM AND THE SOLUTION.....	41
DEGRADATION.....	53
SOME HINTS ABOUT SOME OTHER NOT FULLY ANSWERED QUESTIONS.....	59
APPLICATION.....	63
CONCLUSIONS AND RECOMMENDATIONS.....	67
REFERENCES.....	69

FINAL REPORT  
 PREDICTING SCOUR AT BRIDGES: QUESTIONS NOT FULLY ANSWERED  
 \_\_\_\_\_  
 SCOUR AT SILL STRUCTURES

LIST OF FIGURES

<u>Figure Number</u>	<u>Description</u>	<u>Page Number</u>
1	Flow and Scour Patterns at a Vertical Wall .....	5
2	Approximate and Adjusted Scour Relations .....	8
3	Flume for Scour Study .....	10
4	Size Distributions of Sands and Gravels .....	11
5	Experimental Results; Scour at the Toe of a Vertical Wall.....	13
6	Adjusted, Approximate Analytical Scour Relation .....	14
7	Comparison of Measured and Predicted Scour at the Toe of a Vertical Wall .....	15
8	Flow and Scour Patterns at a Sloping Sill .....	23
9	Approximate Scour Relation for Sloping Sill.....	26
10	Flume for Scour Study .....	29
11	Experimental Results: Scour at the Toe of a Sloping Sill.....	33
12	Adjusted, Approximate Analytical Scour Relationship for Sloping Sill .....	34
13	Comparison of Measured and Predicted Scour at the Toe of a Sloping Sill .....	35
14	Adjusted, Approximate Analytical Scour Relationship for Vertical Wall .....	46
15	Adjusted, Approximate Analytical Scour Relationship for Sloping Sill .....	47
16	Comparison of Various Scour Formulas with Experimental Data.....	60

## PREDICTING SCOUR AT BRIDGES: QUESTIONS NOT FULLY ANSWERED

---

### SCOUR AT SILL STRUCTURES

#### ABSTRACT

The scour at the toe of a vertical wall and at the toe of a sloping sill were investigated experimentally and analytically. Approximate relations for predicting the ratio of the scour depth to the (energy) critical depth were obtained for the two geometries. For the vertical wall, the sediment scoured out left in suspension, and the parameters needed to describe the scour phenomenon were the ratio of the (energy) critical velocity to the fall velocity and the drop in water surface in ratio to the critical depth. For the sloping sill, which is the recommended geometry, the sediment scoured out left as bed load, and the parameters needed to describe the scour phenomenon were the critical depth/sediment size ratio and the ratio of the size of the riprap protecting the sill slope to the the critical depth.

Degradation of the streambed is likely to be the reason for constructing sill structures. A discussion of the degradation phenomena is included to serve as a guide to evaluating to what extent degradation might be a threat to a bridge, culvert or highway.

## SI UNIT CONVERSION FACTORS

The material contained in this report is presented in terms of English units. The following factors may be used to convert between measures used in this report and the International System of Units (SI):

$$1 \text{ foot} = 0.3048 \text{ meter}$$

$$1 \text{ meter} = 3.2808 \text{ feet}$$

$$1 \text{ foot per second (fps)} = 0.3048 \text{ meters per second}$$

$$1 \text{ meter per second} = 3.2808 \text{ feet per second}$$

$$1 \text{ cubic foot per second (cfs)} = 0.0283 \text{ cubic meters per second}$$

$$1 \text{ cubic meter per second} = 35.31 \text{ cubic feet per second}$$



## FINAL REPORT

### PREDICTING SCOUR AT BRIDGES: QUESTIONS NOT FULLY ANSWERED

---

#### SCOUR AT SILL STRUCTURES

#### PROLOGUE

Sometimes it seems like progress takes forever. The weekend of October 1, 1983, saw at least one abutment of one bridge scoured out and one span down, in Tucson, Arizona. In 1947, a large number of bridges were similarly lost in floods in the State of Iowa. For the next ten years, the Iowa Highway Department, in cooperation with the Bureau of Public Roads, sponsored an investigation of scour at bridge piers and abutments at the Iowa Institute of Hydraulic Research. In Bulletin No. 4 of the Iowa Highway Research Board [1], a graphical relationship for the prediction of scour at bridge piers was presented. This was followed in Bulletin No. 8 [2] with an analysis of scour in long contractions, at abutments, and at piers. Previous to 1947, about the only method to predict scour was the statement that the depth of scour measured from the water surface would be twice the "regime" depth. Since most streams did not flow at regime depth, and the statement took no account of pier size, shape, or orientation, few organizations used this method of prediction; most seemed to rely instead on their "engineering judgment". In 1970, in a National Cooperative Highway Research Program investigation [3], ninety-five engineering organizations were asked how they predicted scour at bridge foundations: 46 used engineering judgment, 18 used the Iowa results (17 used Bulletin No. 4), 9 used nine other methods, 3 limited the nominal average velocity (which is either engineering judgment or begging the question), 10 made no predictions (which might be equivalent to predicting zero scour), and 8 did not reply.

In 1970, the suggestion was made that the cost of building bridges so they would not fail because of scour was so small that they should be designed so they presumably would withstand the probable maximum flood [4]. It was also suggested that " ... Existing bridges should be checked for safety in regard to scour, and if they are not safe, the potential for scour should be reduced somehow within the limits of economic justification."

During the holiday season of 1978-79, the State of Arizona experienced floods, and "troubles" with a number of bridges. This led to a study to advance the methodology of assessing the vulnerability of bridges to floods. The reports from that study again recommended that new bridges should be designed for the maximum expected flood, that existing bridges should be evaluated for vulnerability and suggested methodology to perform the recommended evaluations [5]. It should be noted that the Arizona Department of Transportation has implemented these suggestions insofar as resources will permit and has spent a generous amount in making vulnerable bridges less vulnerable. In developing the methodology for assessing vulnerability, it was apparent that there are numerous questions related to scour for which the answers are not completely satisfying to the design engineer who must make decisions of what to do.

Of the several questions not fully answered which surfaced in the aforementioned study, the one which the staff of the Arizona Department of Transportation felt needed to be answered first was the question of the scour to be expected at the toe of a sill structure. For existing vulnerable bridges, a sill structure is one of the first solutions considered -- but it must stay if it is to protect the vulnerable bridge. The scour at the toe of the sill must be predicted if the sill is to be designed so it will stay during the floods that may occur.

## PART I. SCOUR AT THE TOE OF A VERTICAL WALL

### THE QUESTION

In the design of a new bridge which must be founded on erodible material, it will almost always be wisest and most economical in the long run to construct the piers and abutments in such a way that the bridge is not vulnerable, even to the biggest flood expected. The Federal Highway Administration would seem to have taken this position in 1980 since in their suggested procedures for the design of encroachments on floodplains they state, " ... it is assumed ... that the bridge itself will not fail" [6]. Usually the best and cheapest solution for the new bridge is to make the foundations a little deeper, "a little deeper" being enough because the scour depth increases less than the flow increases and the flow increases less than the return interval increases. The extra cost for the deeper foundations is also likely to be minimal because the construction activity is just a little more of the same.

Old bridges and old encroachments on flood plains should be examined in the same way the FHWA has directed that new bridges and encroachments be designed. This is a tremendous job and all bridges cannot be evaluated tomorrow; nevertheless, it needs to be done. Even bridges which have stood fifty years may be vulnerable -- and may have considerable value. However, if an old bridge is found to be vulnerable to scour, it may be difficult and comparatively costly to make it invulnerable. Whether the reason for the vulnerability is that the scour was not predicted well at the time of the design, that the streambed has degraded since construction, that bigger floods can be anticipated based on an extended data base, or something else that has changed does not matter; it probably will not be a simple task to extend the piers and abutments down in order to make the bridge less vulnerable.

An alternative approach to the problem is to do something to insure that the bottom of the possible scour hole will be above whatever is the permissible elevation. One way of accomplishing this end is to raise the streambed to some desired elevation by putting a sill or drop structure across the stream downstream from the bridge. One of the many geometries which can be used for the sill structure is a vertical wall, but the design of the wall requires that the scour at the toe be predicted. After all, the wall cannot be allowed to fail if its purpose is to protect the bridge so it will not fail. Thus, the question in hand is the prediction of the scour at the toe of a vertical wall. It is assumed that the structural and foundation engineers can design the wall after the hydraulic engineer has made the scour prediction.



$$\frac{V_0^2}{2g} = \frac{V_c^2}{2g} + \Delta WS = \frac{y_c}{2} + \Delta WS \quad (1)$$

$$b_0 = \frac{q}{V_0} \quad (2)$$

The flow in the scour hole will be that of a submerged jet of initial velocity  $V_0$  and width  $b_0$ . There will be first a zone of flow establishment of length  $x_0$  and then a zone of established flow. The submerged jet is affected by the limited space for expansion and by the fact that it impinges upon the bottom of the scour hole, penetrates the erodible bed somewhat, is turned upward to flow out of the scour hole along the sloping face which is about at the angle of repose of the sediment. Nevertheless, the width of the initial discharge  $q$  as it leaves the scour hole is about [8]:

$$b = b_0 + K_1(x - x_0) = b_0 + K_1(x - K_2 b_0) \quad (3)$$

The length of the submerged jet can be taken as

$$x = K_3 D_s \quad (4)$$

where  $D_s$  is the depth of the scour hole measured from the tailwater surface. If  $\alpha$  is the angle from the horizontal that the jet leaves the scour hole, the vertical component of the velocity ( $V \sin \alpha$ ) of the jet as it leaves the scour hole must be equal to the fall velocity ( $w$ ) of the sediment if the sediment is to escape in suspension at the limiting size of the scour hole. Algebraic manipulation results in the following expression for the depth of scour:

$$\frac{D_s}{y_c} = \frac{\sin \alpha}{K_1 K_3} \frac{V_c}{w} - \frac{(1 - K_1 K_2)/K_1 K_3}{\sqrt{1 + \frac{2\Delta WS}{y_c}}} \quad (5)$$

Arbitrarily, best guess values of  $\alpha = 35^\circ$ ,  $K_1 = 0.09$ ,  $K_2 = 6$ ,  $K_3 = 3$  were used to illustrate the nature of the relationship as shown in Figure 2. The dimensionless scour ratio increases with the ratio of the reference (critical) velocity to the fall velocity of the sediment, and also increases with the dimensionless drop in the water surface as would be expected. If the arbitrary values chosen are not too unreasonable, it would appear that depths of scour of 10 to 40 times the critical depth are very possible. Scour is possible for values for the critical velocity/fall velocity less than unity because the drop in water surface elevation results in a jet velocity entering the tailwater which is greater than the critical velocity. The effect of the dimensionless drop in water surface elevation is surprisingly small; at a velocity ratio of 4 the scour depth ratio is only increased 16% as the drop ratio increases from 1 to 8, and then only increases 6% as the drop ratio increases to infinity.

Several simplifying assumptions were necessary to obtain Eq. (5); therefore, it should not be expected that the final family of curves will be just like those shown in Figure 2. However, they should be somewhat similar. The submerged slot jet, more accurately described, would have the depth of scour varying with the square of the velocity; however, as will be seen, the experimental data indicate the depth of scour varies as a fractional power of the velocity.

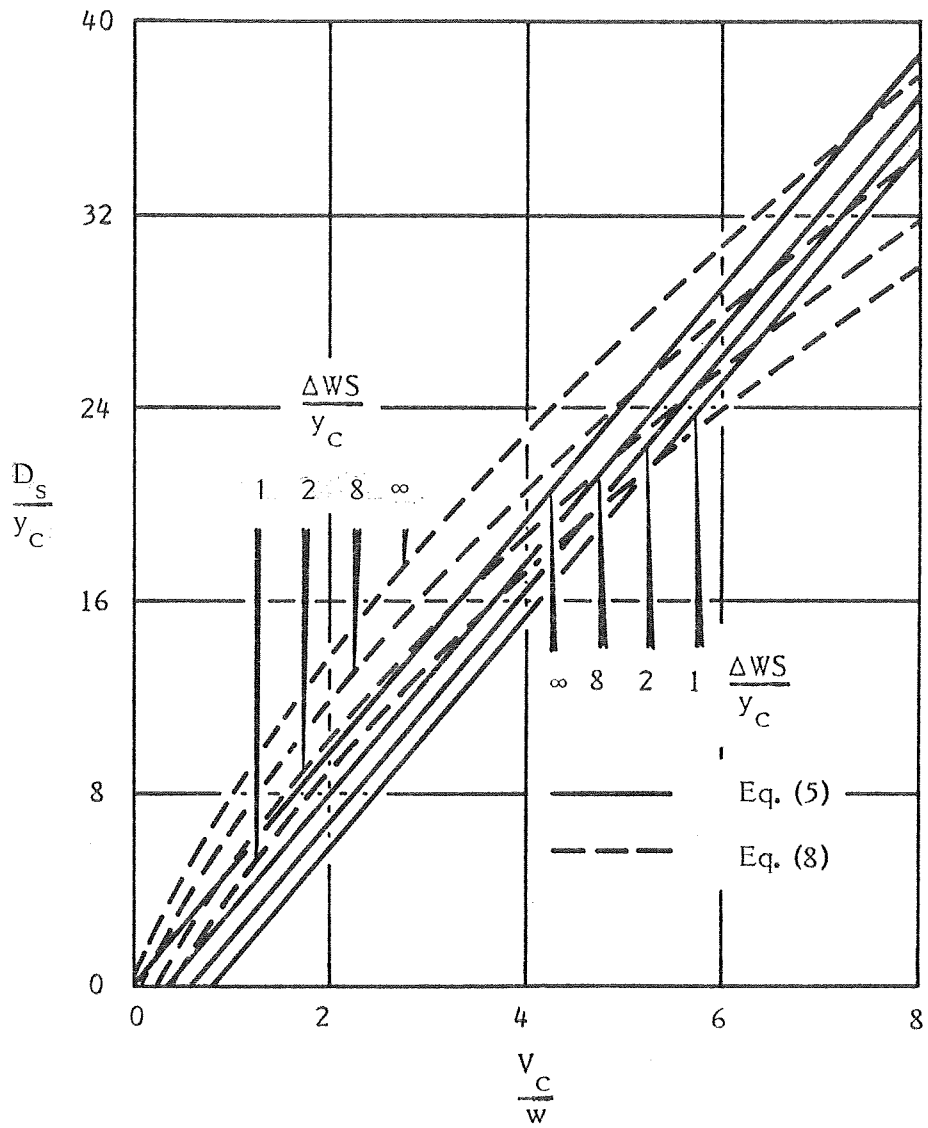

FIGURE 2. Approximate and Adjusted Scour Relations.



## THE EXPERIMENTS

The laboratory experiments on scour at the toe of a vertical wall were performed in the two-foot wide flume shown in Figure 3. The vertical wall was simulated with wooden boxes that could be stacked to various heights in the four-foot-deep section of the flume. The discharge, measured with a V-notch weir, was varied to give critical depth values between 0.02 and 0.2 feet. The tailwater was set to give values of  $\Delta WS/y_c$  between 2 and 16. In the first experiments the tailwater was set at the elevation of the crest of the drop; a  $\Delta WS/y_c$  value of unity. The flow for this condition was very unstable; the nappe leaving the overfall alternating, rather randomly, between first penetrating and then riding the tailwater. When it penetrated it formed the expected scour hole; when it rode the tailwater a strong, stable eddy underneath the surface flow dragged bed sediment back refilling the scour hole. Because of the alternate scouring and filling, the scour hole did not give any signs of reaching a limit -- at least not for a long, long time. A scour depth predicted by extrapolating back from greater drop heights, therefore, should be a conservative, but possible value, if the penetrating nappe persists for enough time.

The size distribution of the four sediments used are shown in Figure 4; the median diameters are 0.30, 0.66, 6.1, and 14.7 mm (0.012, 0.026, 0.24, and 0.58 inches). The fall velocities of quartz spheres of these sizes are 0.13, 0.35, 1.7, and 3.2 fps, respectively; the measured fall velocities are 0.07, 0.25, 0.95, and 1.62 fps, respectively. In the highly turbulent velocity field of the flow in the scour hole, the fall velocity which should describe the behavior of the sediment particles is probably not either of these values, but should be related to either or both of these values. Perhaps a  $K_4 = \frac{w}{w_0}$  where  $w_0$  is the fall velocity of the quartz sphere in still water having a diameter equal to the sieve size (clear space between wires) of the median sediment particle is needed in Eq. (5) to

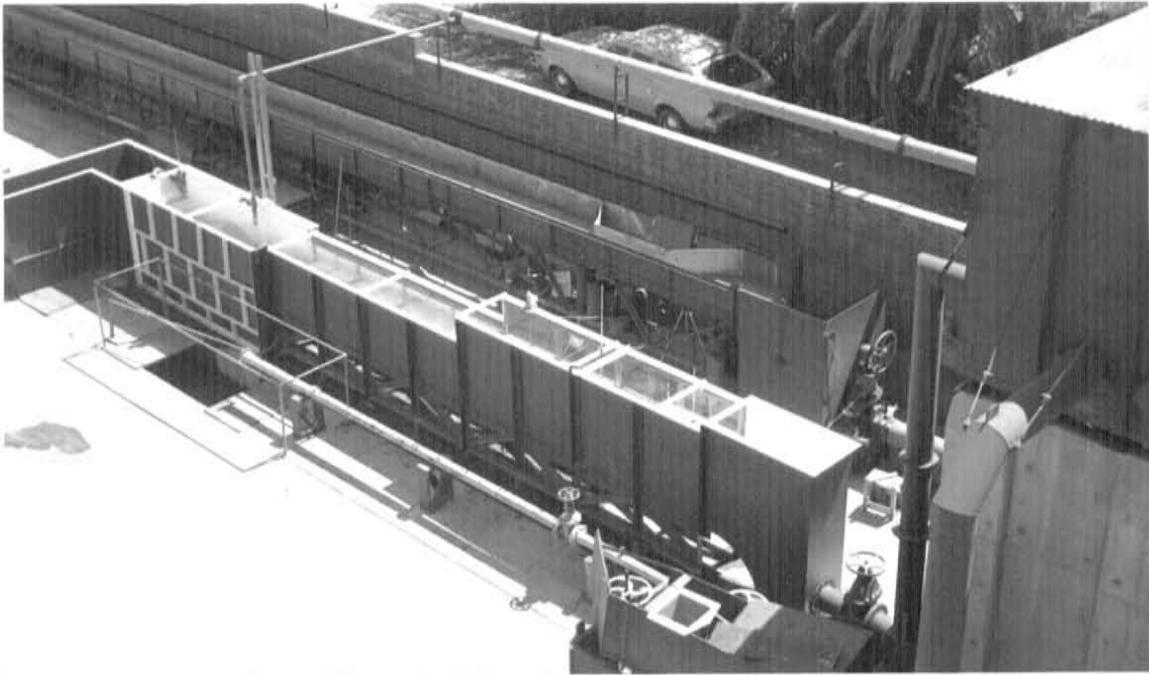

FIGURE 3. Flume for Scour Study.

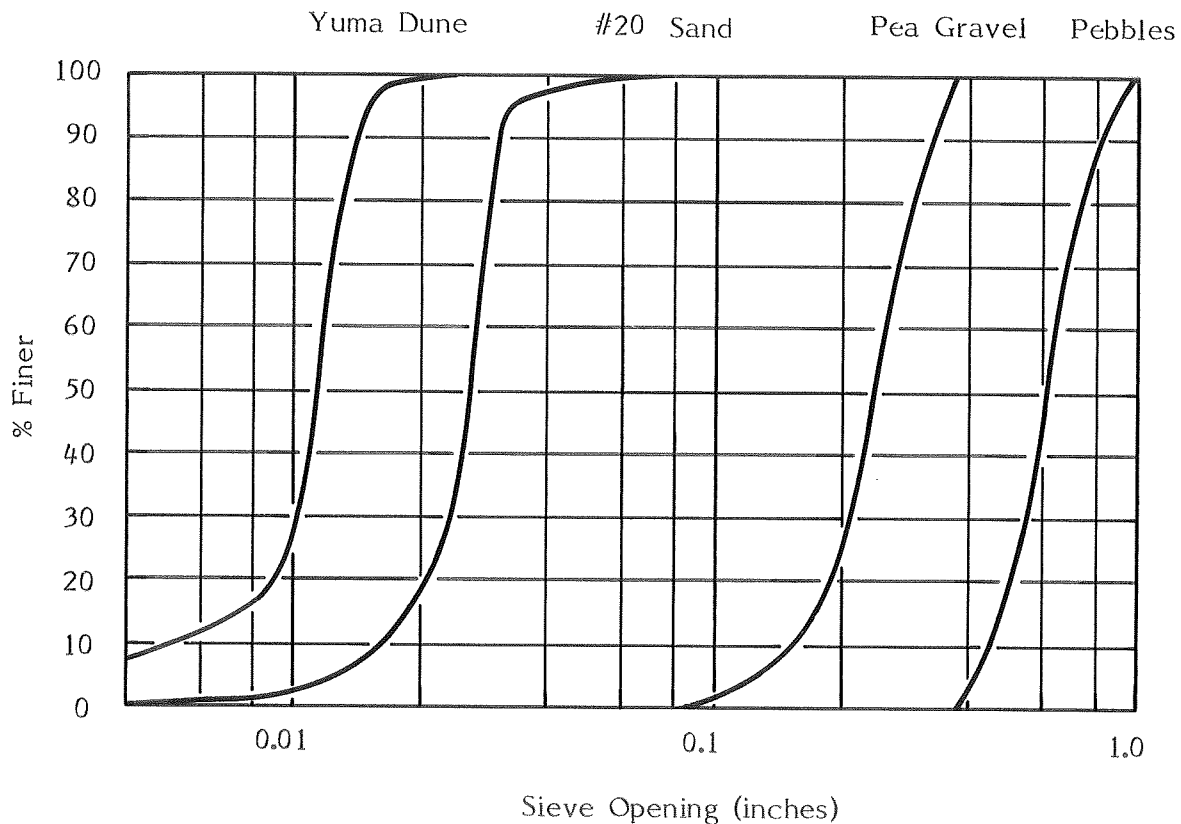

FIGURE 4. Size Distributions of Sands and Gravels.

correct the fall velocity, but its value is unknown.

For drop height ratios greater than 2, the nappe always penetrated, but the flow pattern was not exactly what one would call stable; the nappe wavered slowly a little, probably due to changes in the air pressure under the nappe, the submerged jet was more erratic with the position of jet impingement moving back and forth and the location of the jet escaping the scour hole varying as the "stable" eddies on the two sides of the jet increased and decreased in size and position. For all the secondary flow, the eddying, and the large scale turbulence, the essential description of the flow in the scour hole was still that of a submerged jet.

The results of these experiments are shown in Figure 5. Although the data points plot in the general manner of Eq. (5) (note that Figure 2 is an arithmetic

plot; Figure 5 is a logarithmic one) to fit the equation to the points, it is necessary to have variable coefficients. If A and B are the coefficients of the first and second terms on the right hand of Eq. (5), a fairly good fit is obtained by writing

$$A = 8 \left( \frac{V_c}{w_o} \right)^{-1/4} \quad (6)$$

$$B = 6 + \left( \frac{V_c}{w_o} \right) \quad (7)$$

so that Eq. (5) becomes

$$\frac{D_s}{y_c} = 8 \left( \frac{V_c}{w_o} \right)^{3/4} \frac{6 + \frac{V_c}{w_o}}{\sqrt{1 + \frac{2 WS}{y_c}}} \quad (8)$$

Eq. (8) is plotted as dashed curves in Figure 2 to compare it with the approximate solution, Eq. (5); Eqs. (6) and (7) are probably oversimplified expressions for the needed coefficients. A should also be dependent on the slope of the downstream face of the scour hole or the slope of the escaping submerged jet, and on the relation between the real and nominal fall velocity, and both A and B should probably be functions of the size of the scour hole as much or more than of the flow velocity/fall velocity ratio. Figure 6 is a repeat of Figure 5 with the family of curves represented by Eq. (8) added. Figure 7 is a comparison of depth of scour as measured and as computed by Eq. (8).

$\frac{\Delta_{WS}}{y_c}$	Pebbles	Pea Gravel	#20 Sand	Yuma Dune
2	▽	○	△	□
4	▽	●	▲	■
8	▽	●	▲	■
16	▽	●	▲	■

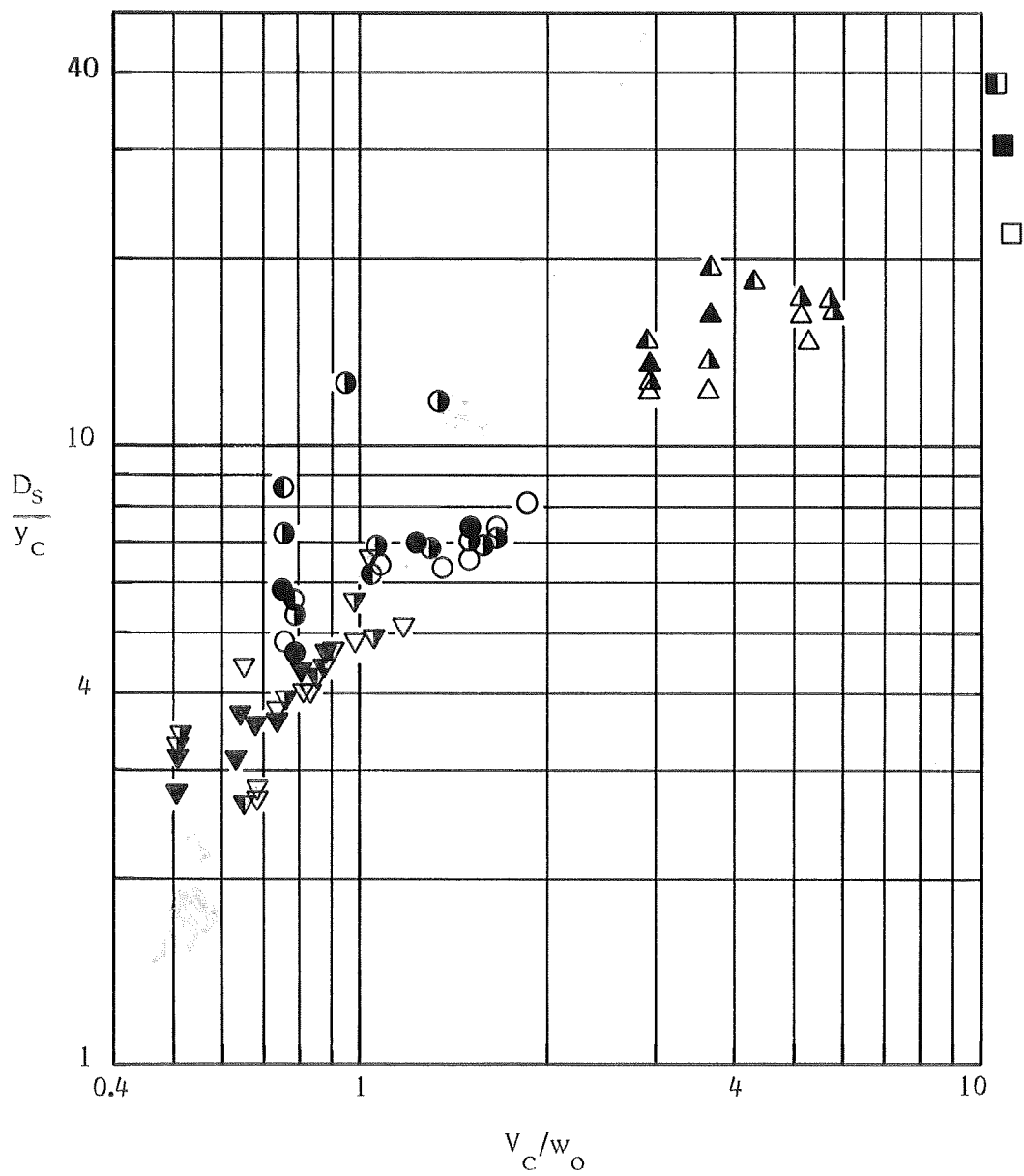

FIGURE 5. Experimental Results; Scour at the Toe of a Vertical Wall.

$\frac{\Delta WS}{y_c}$	Pebbles	Pea Gravel	#20 Sand	Yuma Dune
2	▽	○	△	□
4	▽	●	▲	■
8	▽	●	▲	■
16	▽	●	▲	■

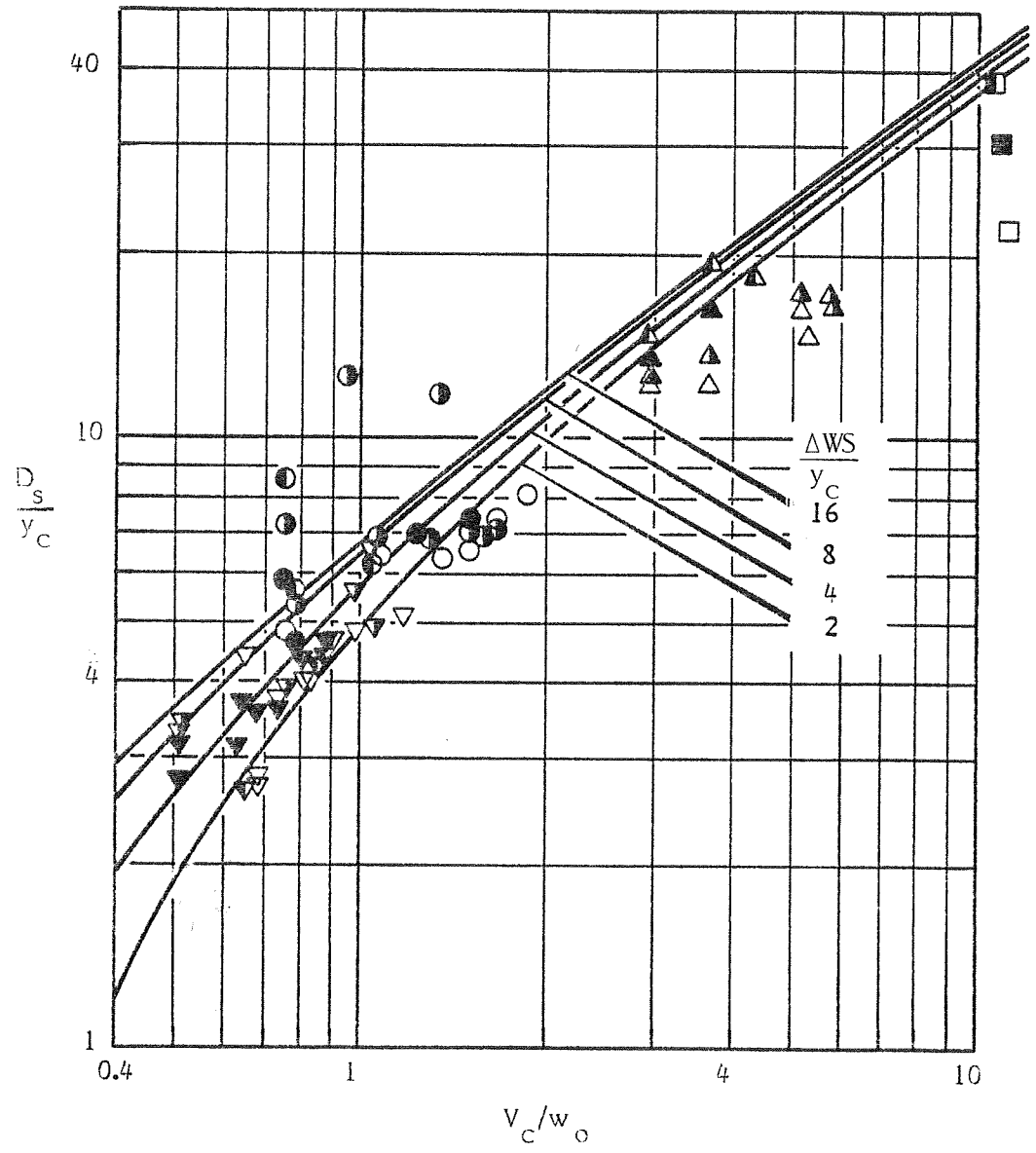

FIGURE 6. Adjusted, Approximate Analytical Scour Relation, Eq. (8).

$\frac{\Delta WS}{y_c}$	Yuma Dune	#20 Sand	Pea Gravel	Pebbles
2	□	△	○	▽
4	◻	▲	●	▼
8	■	▲	●	▼
16	◼	▲	●	▼

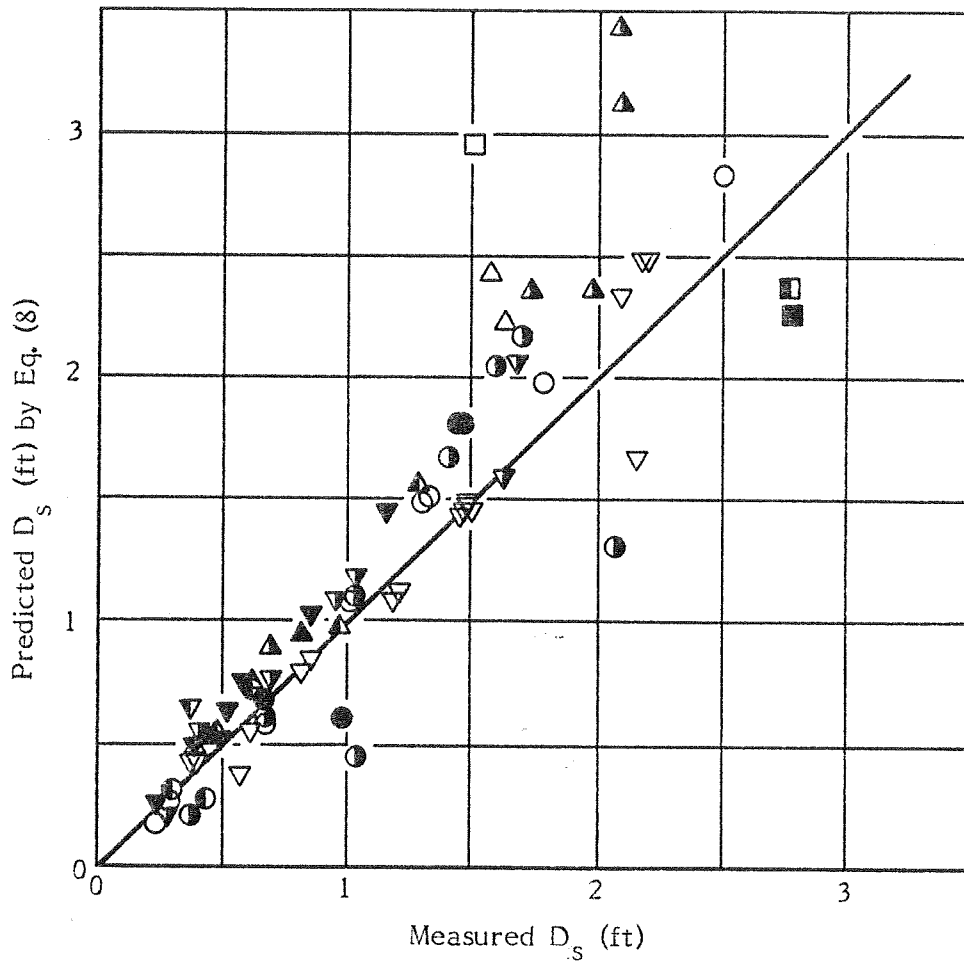

FIGURE 7. Comparison of Measured and Predicted Scour at the Toe of a Vertical Wall.





## APPLICATION

Can Eq. (8) or Figure 6, which were based on model scale measurements of scour at the toe of a vertical wall, be used for predicting scour at a real vertical drop structure in a real river during a real flood event? If the flood lasts long enough, if there is not an armouring (riprapping) of the scour hole either by natural self-sorting or artificially, and if the flow approaching the drop is essentially clear water (not carrying a sediment load of the size of material being scoured out), the answer is "yes". Consider a model with a  $y_c = 0.1$  ft and a sand of 6mm (0.02 ft) median diameter, and two prototypes, one with a  $y_c = 1$  ft and a gravel of 2-1/2 inches (0.2 ft), the other with a  $y_c = 10$  ft and boulders of 2 ft. The  $\Delta WS/y_c$  values of the three cases would be the same, and for the sake of argument, the  $D_s/y_c$  values also. The critical (reference) velocities would differ by the square root of the length ratio of the model and prototypes, or by  $\sqrt{10}$  and  $\sqrt{100}$ ; the nappes would be similar in shape and the velocities where the nappe plunged into the pool would be in the same ratios as the reference velocities. The submerged jets should be similar with velocity patterns the same for all three sizes of scour holes; the velocity magnitude and direction for each case as it leaves the scour hole should be the same if measured in proportion of the critical, reference velocity. Thus, if the sediment is sized such that the fall velocities for the three cases differ by the  $\sqrt{L_r}$  (the three sediments were chosen so this would be true), they should behave the same in being entrained and leaving the scour hole in suspension -- at the limit in not quite leaving the scour hole in suspension. The nature of the highly turbulent, free, submerged jet, and the amount of activity of the sediment at the bottom of the scour hole where the jet impinges (even at the limit) is such that Reynolds effects should be very small. Therefore, Eq. (8) should provide a useful prediction of the maximum scour that can be expected to occur at the toe of a vertical wall.

Unfortunately, this predicted scour is quite large; which leads naturally to the question of what factors could operate to reduce the scour found in the field situation. Several factors have been noted or can be inferred from the experiments which have been conducted:

1. The time factor which would be important if the peak (or a high) flow does not continue long enough for the scour hole to reach its limit.
2. An approach flow which supplies sediment to the scour hole.
3. A self-sorting process which results in a scour hole lined with the coarser fraction of the original bed material.

The rate of scour is very large at the beginning and half the depth of the scour hole can be achieved in 5% or less of the nominal time to reach the limiting scour depth. The limit is reached asymptotically with time so the nominal time is obtained by extending the semilogarithmic curve of the active scour phase to the limiting depth of scour. The time factor for scour is not yet adequately understood, but at the laboratory scale, the time to reach the limit was of the order of an hour (sometimes less). Because one might expect the time requirements to be longer in the field, one might expect that the scour could be at least half of the limiting scour even for flash floods due to thunderstorms.

A few runs have been conducted with sediment added to the approach flow at a rate such that the critical flow just before the overfall keeps the bed swept clear. For this rate of sediment supply, the depth of scour was approximately three-fourths of the limiting depth of scour for the clear-water case. For sediment supply rates greater or less, the depth of scour would be less or more than 75% of the limit for the clear-water case. Again, time might not be sufficient to attain this lesser limit, but even in flash floods the scour is likely to be something like 40% of the maximum scour expected in a clear-water flow.

That leaves self-sorting as the factor that could reduce the scour to a more acceptable amount. Experiments have not been conducted with a mixed sediment, but a preformed scour hole has been artificially riprapped successfully. The finest sand was covered with three layers of the pea gravel and then two layers of the pebbles. The upper surface of the pebbles was at an elevation of 1-1/2 times the depth of scour that would be expected for the pebbles. There was some movement of the pebbles and some change in the shape of the preformed scour hole, but not enough to result in deeper scour. Performing the scour hole to a depth 1-1/2 times the predicted depth of scour was necessary because there was a great amount of action at the limiting depth of scour -- particles being removed from the bottom, cast up on the downstream slope, then slumping down again. In a preliminary run, the pea gravel was omitted and the fine sand leached through the pebbles with the result that the scour hole kept enlarging. In a field situation, it might be necessary to cover the original material with a porous plastic membrane which, in turn, would be covered with an intermediate-sized material below the riprap layer.

Artificially riprapping the scour hole would be more certain than depending on self-sorting. If there is large rock in the bed material, it can be the source of the riprap. Depending on the kind of vertical wall placed, it may be necessary to excavate the stream bed to the base of the vertical wall. If that is the construction procedure, only a little more excavation would be needed for performing the scour hole. If the desired size of riprap and filter layer is to be found in the excavated material, they can be obtained by passing the material over a couple of grizzlies to separate out the coarsest fractions. Additional, or larger, material can be added as needed and the preformed scour hole riprapped. The rest of the material can be replaced in the excavation if there is nothing better to do with it. The "best" size of riprap, depth of scour, and height of wall becomes a

standard problem of design of selecting the combination which will be the least cost to obtain the desired protection. This will probably always mean designing for the maximum expected flood because the loss that could occur is not only the vertical wall, but also the bridge it is meant to protect.

## PART II. SCOUR AT THE TOE OF A SLOPING SILL

### THE QUESTION

In the preceding part of this report, it was cited that the scour at the toe of a vertical wall could be ten times or more the critical depth of flow ( $y_c$ ) at the brink at the top of the wall. If  $y_c = 2$  ft, this would be a depth of scour of 20 feet or more for a unit discharge of 16 cfs/ft, or a total discharge of 1,600 cfs in the stream 100-ft wide. This would be quite a structure in a fairly small stream. If  $y_c = 8$  ft, the depth of scour would be 80 ft or more for a unit discharge of 128 cfs/ft, or a total discharge of 51,200 cfs in a river 400-ft wide. This might be representative of the maximum expected flow in one of Arizona's larger streams, but the structure would be very costly.

The actual scour that would be experienced might be less for several reasons: (1) if the flow is transporting sediment, the scour might be 25% less (depending on how much bed material load is being transported), (2) if the peak is very short, the full limiting scour may not be achieved and the scour might be as much as 50% less, and (3) if the coarsest fraction of the bed material is left behind in a self-sorting action in the scour process, the scour can be less, but would be 50% greater than would be predicted if the armour layer were the sediment size. All of these effects cannot be piled one on top of another so the scour is only  $(0.5 \times 0.5 \times 0.75)$  about 20% of that predicted for the limiting scour for the clear-water case. The interplay between the various effects would be small, and even a reduced scour prediction results in a structure of considerable size, strength and cost.

Another geometry for a drop structure is the sloping sill. This type of structure has the obvious advantage that it can be built of the native alluvial material at hand; the one structural requirement being that the slope is flat enough so the soil mass is stable when saturated and subject to the pressure

and seepage forces during the flood as well as its own weight. If the stable slope is flatter than 1 vertical : 4 horizontal, the native material may be improved by some kind of stabilization technique or by mixing with imported material. The hydraulic questions which need answering are the depth of scour and shape of scour hole to be expected, and the size of riprap needed to protect the surface of the sill.

## FLOW AND SCOUR PATTERNS EXPECTED

The general situation for the sloping sill is as shown in Fig. 8. Upstream of Section c is the normal approach flow. At the brink of Section f the flow depth is slightly less than the nominal (energy) critical depth because the flow is curvilinear and the pressure is not hydrostatic. At Section o where the flow plunges into the tailwater, the flow depth should be close to normal on the sloping sill, especially if the riprap covering the sill is large. Beyond Section o the flow expands as a submerged jet; the sloping sill serves partly as a plane of symmetry, partly to contribute to boundary layer growth and the expansion of the jet. At Section s, the boundary shear is equal to the critical tractive force of the bed material of the stream; therefore, the scour is limited. Beyond Section s, the scour will take a shape such that the boundary shear is equal to the critical tractive force (which will be somewhat larger on the upslope of the scour hole than it is in normal flow on a gentle slope).

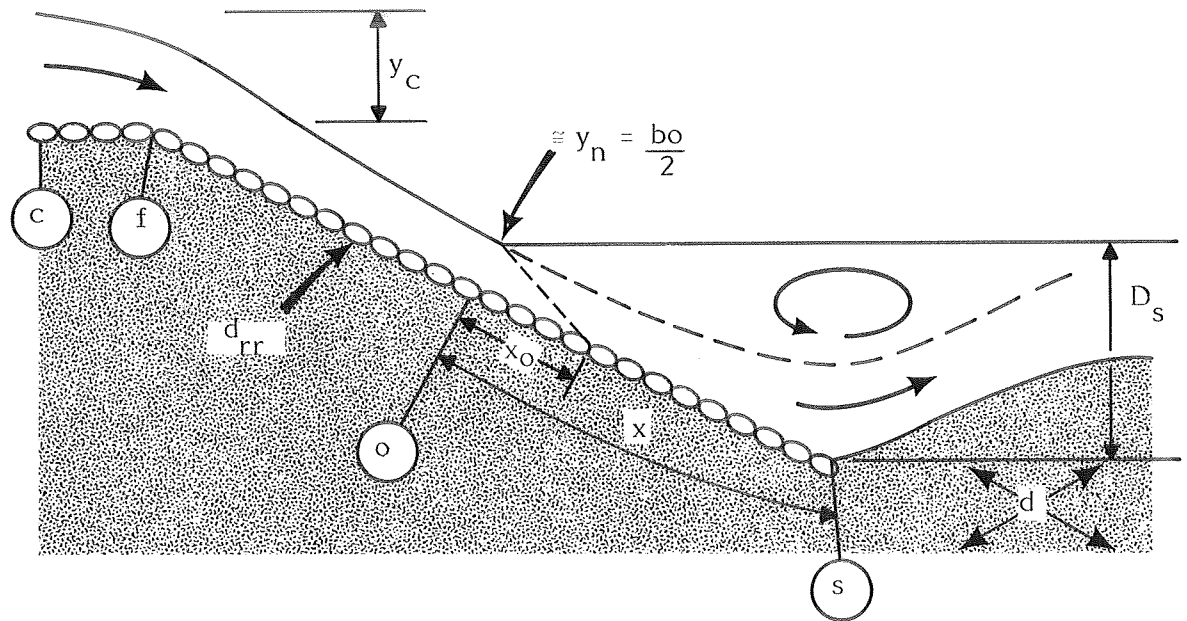

FIGURE 8. Flow and Scour Patterns at a Sloping Sill.

Consideration of these sections permits an approximate analysis for the depth of scour to be expected. The flow can be characterized by the (energy) critical depth as:

$$y_c = \sqrt[3]{q^2/g}$$

or,

$$q = \sqrt[3]{g y_c^3}$$

Even if the approach flow is supercritical, the critical depth should be an adequate measure of the scale of the flow. The brink depth might be a little less than the overall depth, which itself would be slightly less than the nominal critical, but that should only mean that normal depth on the sloping sill would be attained sooner. The critical depth has the advantage also that it can, in effect, substitute for the discharge per unit width, thus reducing the variables needed to describe a particular situation by one. The normal flow on the sloping sill can be obtained from the Manning formula using a Strickler-type evaluation of resistance,  $n = 0.0344 d_{rr}^{1/6}$ :

$$\sqrt[3]{g y_c^3} = q = \frac{1.49}{0.0344 d_{rr}^{1/6}} y_n^{5/3} (\sin \theta)^{1/2}$$

which reduces to:

$$\frac{y_n}{y_c} = 0.45 \left( \frac{d_{rr}}{y_c} \right)^{1/10} \quad (9)$$

where  $d_{rr}$  is the size of the riprap protecting the sloping sill.

Equation (9) would indicate that the normal depth on a sloping sill 1V:4H with a riprap diameter equal to the critical depth would be half the critical depth, and that if the riprap was 1/100 of the critical depth, the normal depth would be a quarter of the critical depth. The latter case is probably true; the former case is probably not true. When the size of the riprap is about the same as the depth of flow, the resistance to flow is probably relatively larger -- a fair share of the flow is in between and through the riprap.



After the flow becomes a submerged jet, it can be roughly described as:

$$b_0/2 = y_n$$

$$b = b_0 + K_1 (x - x_0)$$

$$b = b_0 + K_1 (K_2 D_s - K_3 b_0)$$

where  $b$  is the full width of the jet about a plane of symmetry which is the face of the sloping sill,

$b_0$  is the initial full width of the jet,

$x$  is the length of the jet along the sloping sill to the bottom of the scour hole of depth  $D_s$  measured from the tailwater surface, and

$x_0$  is the length of the potential core.

Now, if the best guess assumptions are that  $K_1 = 0.04$ ,  $K_2 = 17$ , and  $K_3 = 6$

$$b/2 = 0.76y_n + 0.082 D_s$$

and

$$V = \frac{q}{b/2} = \frac{g^{0.5} y_c^{1.5}}{0.76 y_n + 0.082 D_s}$$

The state at the bottom of the scour hole is that the boundary particle shear is equal to the critical force and this state will be approximated by

$$\frac{\tau_0'}{\tau_c} = \frac{V^2}{120(b/4)^{1/3} d^{2/3}} = 1$$

which, with substitutions and algebraic manipulations, becomes

$$\frac{g^{0.5} y_n^{1.5}}{0.76 y_n + 0.082 D_s} = \sqrt{120} \left( \frac{0.76 y_n + 0.082 D_s}{2} \right)^{1/6} d^{1/3}$$

$$0.082 \frac{D_s}{y_c} + 0.76 \times 0.45 \left( \frac{d_{rr}}{y_c} \right)^{1/10} = \left( \frac{2^{1/6} g^{1/2}}{120^{1/2}} \right)^{6/7} \left( \frac{y_c}{d} \right)^{2/7}$$

or,

$$\frac{D_s}{y_c} = 7.7 \left( \frac{y_c}{d} \right)^{2/7} - 4.2 \left( \frac{d_{rr}}{y_c} \right)^{1/10} \quad (10)$$

Equation (10) then is the form of relationship which it is hoped will predict the depth of scour; however, it is to be expected that the coefficients and exponents will have to be adjusted because of the many approximations that were made in the derivation. This very approximate relationship is shown in Figure 9 merely to give a sense of what depth of scour might be anticipated. It would appear that depths of scour half of those found for the vertical wall can be anticipated.

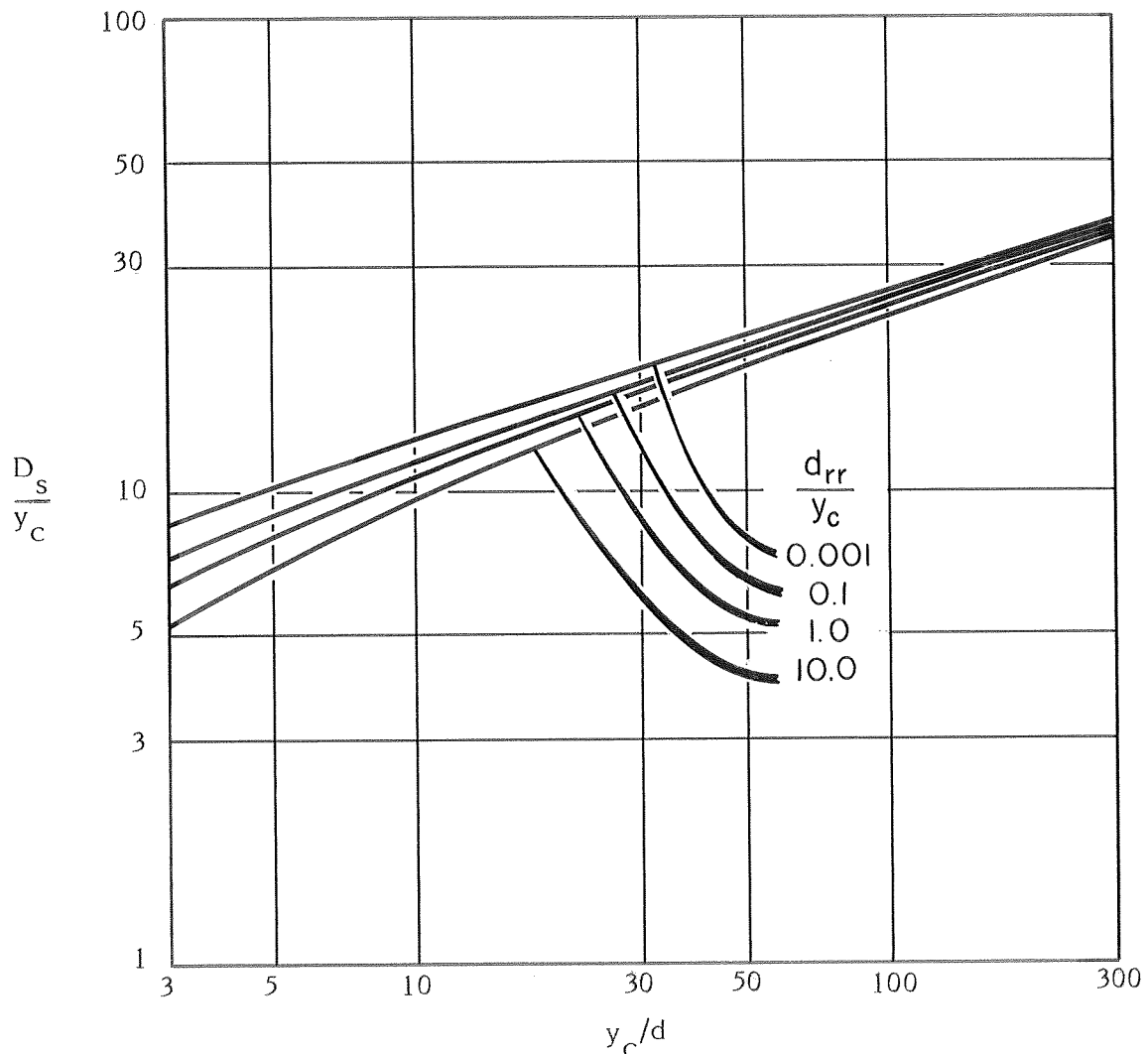

FIGURE 9. Approximate Scour Relation for Sloping Sill.

The other hydraulic question that needs attention is the size of riprap needed to protect the surface of the sloping sill. In this situation, the total shear is also the particle shear, and it can be shown that the ratio of the critical tractive force on the slope to that on the horizontal is:

$$\frac{\tau_c(\text{slope})}{\tau_c(\text{bed})} = \cos \theta \left( 1 - \frac{\tan \theta}{\tan \phi} \right) \quad (11)$$

$$\tau_0 = y_n \sin \theta$$

If the slope is 1V:4H, the angle of repose  $\phi$  is  $30^\circ$ , and the critical tractive force on the bed is  $4d$ , and remembering Eq. (9):

$$d_{rr} = 2.8 y_c \quad (12)$$

For this size of roughness, neither the evaluation of the critical tractive force, of the Manning  $n$ , or of the normal depth would be correct. What Eq. (12) does indicate very decisively, however, is that the riprap cannot practically be large enough to stay by itself on a 1:4 slope.



## THE EXPERIMENTS

The laboratory experiments on scour at the toe of a sloping sill were performed in the same two-foot wide flume as was used for the experiments on scour at the toe of a vertical wall. The flume is shown in Fig. 10. The sloping sill was simulated with a wooden box, the top of which slanted down at a slope of 1 vertical to 4 horizontal. The painted wooden surface was assumed equivalent to a concrete slab. The brink was rounded to eliminate separation of the flow, and in the case of a riprapped slope, to avoid undue forces on the rock at the brink.



FIGURE 10. Flume for Scour Study.

The riprap used was either the pebbles of a median size a little over one-half inch, or fist-size rocks of about three inches in diameter. These two sizes simulate riprap of about the size of the critical depth of flow and of a fraction

of the critical depth of flow. Both needed to be anchored with chicken wire or hardware cloth and staples driven into the top of the wooden box. The rocks were stable by themselves for small critical depths of flow, but moved when the critical depth was 0.8 of the average rock diameter, and had to be anchored for larger critical depths.

The few rocks that were the easiest to move because of their shape, placement among other rocks, and the local fluid forces were the only ones that moved - all the rocks did not move when  $y_c$  was just barely greater than 0.8 of the rock size. But this is the concept of the critical tractive force - when the most exposed particle moves. If there is only one layer of riprap, the loss of one rock changes (increases) the fluid force on a neighboring rock and changes (decreases) the resistance to movement of another neighboring rock. Gradually, the layer of riprap unravels and the sill would erode, concentrating the flow which would lead to the destruction of the sloping sill.

It is recommended that the riprap be anchored in place with heavy galvanized wire mesh and soil anchors. Even in the case of a concrete slab(s) instead of riprap, soil anchors should be used; otherwise, the concrete needs to be thick enough (to be heavy enough) to resist an uplift including stagnation pressure under the slab. Whether the use of a soil-cement covering on the sill would be feasible depends on whether the soil cement adequately resists wearing away by the sand and rock moving along as bed load.

The discharge, measured with a V-notch weir, was varied to give critical depth values of between 0.06 and 0.4 feet. The tailwater was usually set to give values of  $\Delta WS/y_c$  of 2 or 8. This parameter proved to be of little consequence with just a hint that the lesser drop resulted in less scour. However, the margin of error, especially because of the non-two-dimensionality of the flow and the scour, obscured the relatively small effect of the drop height. At the brink (because of curvilinear flow) the depth is less than the nominal energy critical. The normal depth is not

too much smaller than the nominal critical, and the flow approaches normal quite quickly. This fortunate finding simplifies the problem and the relationship.

The size distribution of the four sediments used were the same as in the vertical wall experiments as shown in Fig. 4. The coarsest sediment, designated "pebbles", was also used as one of the riprap coverings of the sill. The other protective riprap used was selected rocks with an average diameter of 3.2 inches (80 mm).

At the beginning of the development of a scour hole, the jet could literally blast the sand away, tossing it into suspension. As the hole developed, the sand pebbles (even the fine sand particles) moved as bed load, and at the limit the particles at the bottom of the scour hole were motionless. This is in contrast to the scour hole at the toe of the vertical wall where the sand particles, gravel or pebbles at the bottom of the limiting scour hole were actively moving about, being suspended, falling on the downstream slope of the scour hole, and slumping back into the scour hole.

In the case of the vertical wall, the limit was achieved when the upward component of the flow leaving the scour hole was no longer able to lift the particles out of the scour hole in suspension. In this case of the sloping sill, the limit was reached when the fluid shear on the bottom of the scour hole was no longer able to move the sand particles as bed load; the downstream slope of the scour hole continued to erode (but not much) until it also achieved this condition.

In the first run that was made, there was a very large difference in the scour on the two sides of the flume. It turned out that the sloping sill had been installed so that it was not level across the flume; when corrected, the scour hole was almost, but not quite, level across. In subsequent runs, a variation in scour depth across the flume was always found; sometimes deeper on one side, sometimes deeper in the center, sometimes higher in the center. The lack of two-dimensionality was probably due in part to the wall influence on the expanding submerged

jet. However, especially with the larger protective riprap on the sill, a poorly placed rock could deflect part of the jet in a way which would result in a locally deeper scour. This kind of difficulty is probably to be expected in the field, and no further attempts were made to force a more uniform scour hole. The depth of scour which was chosen as being correct for design was the maximum scour -- not the average.

The results of the experiment are shown in Fig. 11. Although the points plot in the general manner of Eq. (10), the points are a good bit lower than the tentative, approximate equation. A much better fit is obtained by adjusting the coefficients and the exponent of the first term so the equation becomes:

$$\frac{D_s}{y_c} = 4 \left( \frac{y_c}{d} \right)^{0.2} - 3 \left( \frac{d_{rr}}{y_c} \right)^{0.1}$$

where  $D_s$  is the scour depth measured from the downstream tailwater,

$y_c$  is the critical depth of flow,

$d$  is the size of the material being scoured (or the riprap blanket in the bottom of the scour hole),

$d_{rr}$  is the size of the riprap layer protecting the surface of the sloping sill.



$d_{rr}$	Yuma Dune	#20 Sand	Pea Gravel	Pebbles
Smooth	□	△	○	▽
Pebbles	▣	▲	◐	▽
Rock	■	▲	●	▽

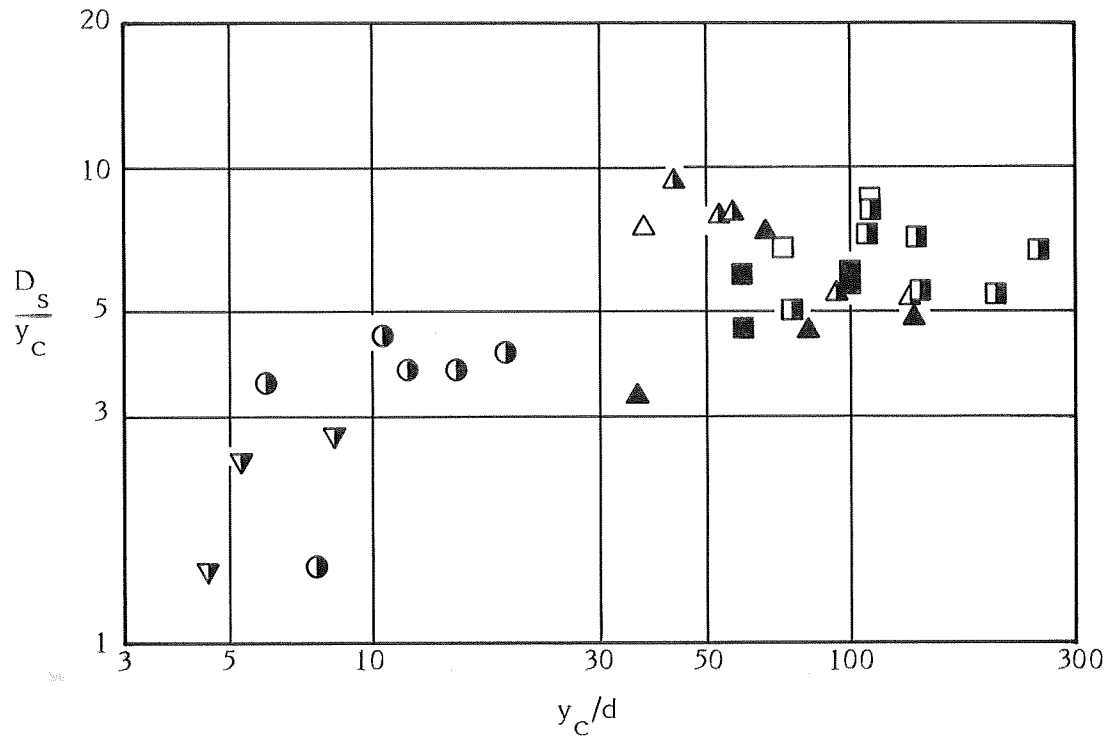

FIGURE 11. Experimental Results; Scour at the Toe of a Sloping Sill.

Figure 12 superposes Eq. (13) on the measured maximum scour points, and Figure 13 is a comparison of the measured maximum scour and the scour predicted by Eq. (13).

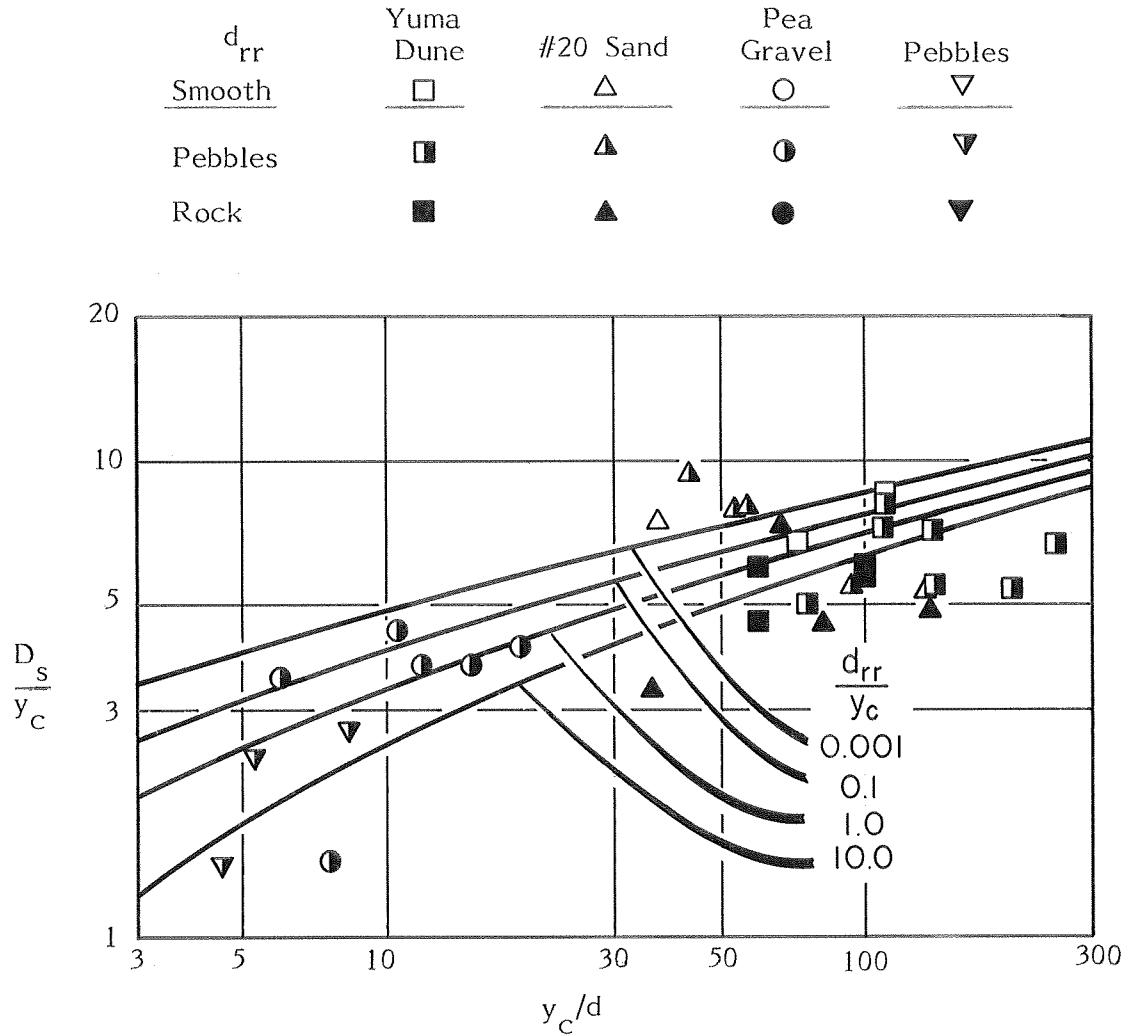

FIGURE 12. Adjusted, Approximate Analytical Scour Relationship for Sloping Sill.

$d_{rr}$	Yuma Dune	#20 Sand	Pea Gravel	Pebbles
Smooth	□	△	○	▽
Pebbles	▣	▲	●	▼
Rock	■	▲	●	▼

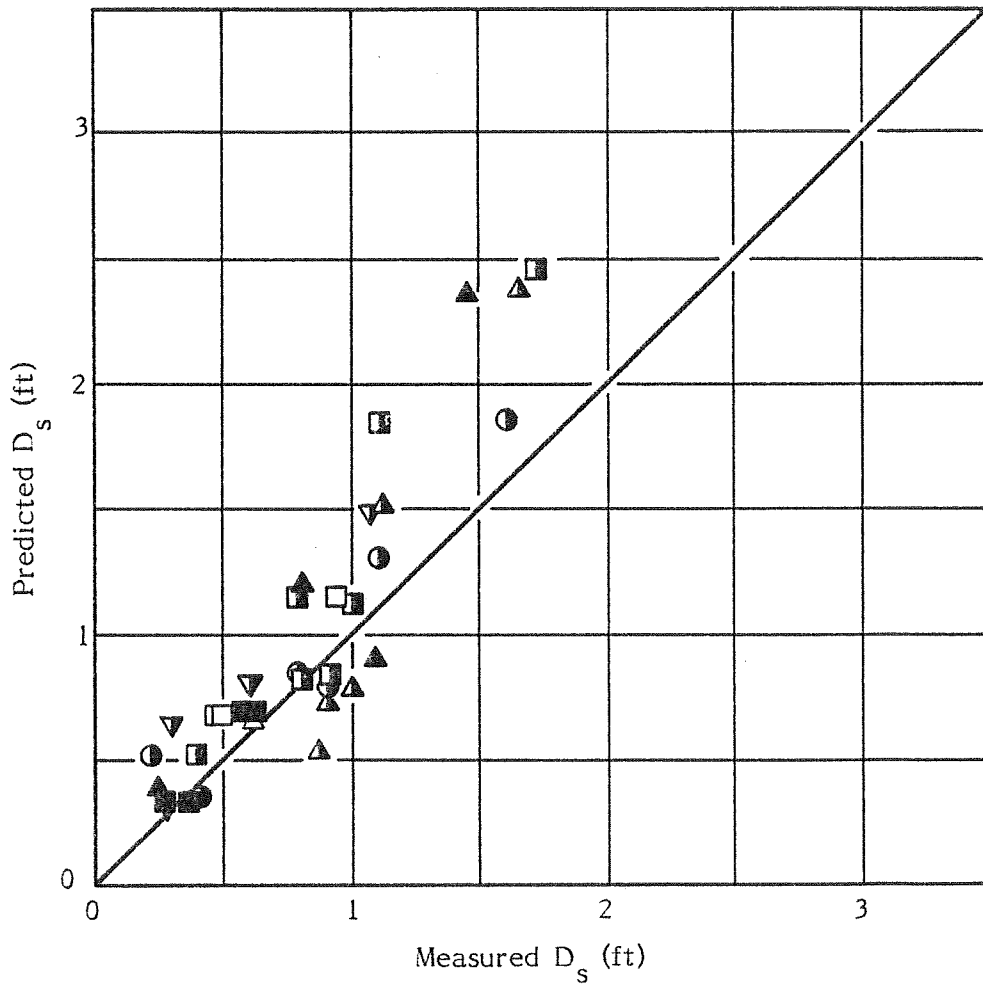

FIGURE 13. Comparison of Measured and Predicted Scour at the Toe of a Sloping Sill.

Experiments were made with a riprap blanket in the bottom of the scour hole at a depth predicted by Eq. (13). At this level, the riprap was very stable; indeed, it could withstand an increase of 60% in the critical depth (i.e., a doubling of the discharge per foot width). The riprap should probably be laid on a filter fabric and a layer of gravel or small rock, but was very stable when laid at a level given by Eq. (13). A preformed scour hole might well be more uniform than a naturally developed one, and, therefore, the riprap blanket could be placed at a higher elevation than indicated by these experiments and Eq. (13). However, there would then be no "safety factor" for a too low estimate of design discharge, or for continued degradation.

Experiments were also made to determine the effect of a sediment load of bed material supplied from the approach reach. When the sediment load was as much as the critical flow at the brink could transport, the depth of scour was half the value for clear-water scour. If the approach flow is subcritical, of course, the reduction in scour would be less.

As  $D_s/y_c$  approaches a value of unity as predicted, the normal depth of flow downstream needs to be evaluated. Certainly,  $D_s/y_n$  will be greater than unity, and  $D_s$  can be greater than would be calculated by the proposed relationship.

## APPLICATION

To illustrate the use of the relationship proposed herein for predicting the scour at the toe of a sloping sill, consider the following situation on a stream in Arizona:

- Channel 220 feet wide, banks 6 feet high, slope 1/2 of 1%,  
and estimated  $n$  value equal to 0.035;
- Discharge for design 10,000 cfs;
- Bed material median diameter 1/8-inch or 0.01 feet (3.2 mm), with  
several percent larger than three inches.

A head cut of eight feet is moving towards a highway crossing of the stream. The charge is to investigate a sill structure to stabilize the head cut and protect the highway crossing.

Assuming a rectangular channel, the following flow characteristics can be found:

$$\text{Normal Flow: } y_n = 5.1 \text{ feet, } V_n = 8.9 \text{ fps, } F = 0.7$$

$$\text{Critical Flow: } y_c = 4 \text{ feet, } V_c = 11.4 \text{ fps}$$

If a sloping sill 1V:4H protected by 12-inch rock covered with anchored, heavy galvanized wire mesh is being considered, the depth of scour would be, according to Eq. (13):

$$D_s = 42.5 \text{ feet}$$

or a scour hole 37.4 feet below streambed. This is too deep to be seriously considered, but is for clear-water scour and if sediment is supplied to the scour hole from the approach flow, the scour would be less. The transport rate would be less than that of critical flow and the scour might be reduced about one-third to:

$$D_s = 28.4 \text{ feet}$$

or 23.3 feet below the streambed. This is much better, but still deep enough to perhaps give a problem for the sidewalls of the sill structure.

There is supposedly some small percentage of the bed material which is larger than three inches. If this material which can be used to riprap the bottom of the scour hole has a mean size of four inches, the depth of scour, according to Eq. (13) is only.

$$D_s = 15.8 \text{ feet}$$

or a bottom of the scour hole only 10.7 feet below the stream bed. Railbank for the sidewalls should be quite possible, especially if tiebacks are used at the top of the rail or piles. About 20 feet of the bottom of the scour hole should be riprapped with a layer 1-1/2 or 2 stones in thickness. If 3% of the bed material is this size, the riprap could be obtained from the native material. If the cost of imported material is less than passing the bed material through a single grizzly, further calculations might show a somewhat larger riprap would reduce the height of the sidewalls enough to be more desirable. However, a predicted scour hole less than five feet (equal to  $y_n$ ) below the water surface should not be accepted.

It is interesting to calculate the anticipated scour at a vertical wall. For the 1/8-inch median diameter bed material according to the equation:

$$\frac{D_s}{y_c} = 8 \left( \frac{V_c}{w_o} \right)^{3/4} - \frac{6 + \left( \frac{V_c}{w_o} \right)}{\sqrt{1 - \frac{2\Delta WS^3}{y_c}}}$$

$$D_s = 107 \text{ feet}$$

which, even if wrong, it is not wrong enough to make a vertical wall a feasible structure unless the scour is somehow inhibited. Inhibiting the scour by ripraping the bottom of the scour hole to achieve the scour depth of the four-inch diameter riprap with the sloping sill would require a riprap 18 inches in diameter. This, of course,

may be beyond the limits of the relationship for scour at the toe of a vertical wall. But even if the answer is wrong, it is not so wrong but what it indicates the sloping sill is a more practical solution.

On the basis of what is now known (or suspected) about scour at the toe of sill structures, it would seem that the sloping sill is the much-to-be-preferred structure. The depth of scour is less, the structure should be much less costly, and the structure can be added to if degradation continues. In the example, it was stated only that there was a highway crossing. If the crossing is a bridge which would be vulnerable if the stream bed was lowered eight feet, the cost of the sill structure would undoubtedly be justifiable. If the highway crossing is a culvert, the same conclusion would probably be reached. If the crossing is just a dip and the traffic is light, the loss might not seem to justify the cost. A point to be considered, however, is whether a dip would still be an acceptable form of crossing. If the dip must be replaced with a culvert, perhaps the loss to be considered is the cost of the culvert which would have to be built -- or the gain is the cost of the culvert that doesn't have to be built.





### PART III. SILL STRUCTURES AS REMEDIAL MEASURES

#### THE PROBLEM AND THE SOLUTION

A sill structure is a discontinuity in a stream where the bed suddenly (or quite suddenly) drops a significant amount. The drop in bed elevation will also have an effect on the water surface elevation with the depth less at the overfall and a flow pattern immediately downstream which is very unlike a standard, normal, channel flow. For small drops in water surface elevation, the jet coming from the sill structure may ride the downstream (or tailwater) surface with a roller below the jet [7]. For the greater drops of more interest, the jet will plunge with a primary roller above the jet. Either the roller or the plunging jet can scour out the bed below the sill structure; the deeper scour being associated with the plunging jet. At some small range in drop of the water surface the jet can be quite unstable alternately riding and plunging.

A sill structure can be a natural condition as in the rapids of the Colorado River through the Grand Canyon, or it can be a structure built by man in an effort to keep the bed of a stream at some desired elevation. A dam differs from a sill structure in that a dam raises the water surface upstream and the reservoir behind a dam serves as a trap for the sediment transported by the flow upstream of the dam. If a sill is installed to raise the bed elevation of a stream, it is really a small dam but with too little reservoir volume to significantly affect the streamflow. However, insofar as it raises the water surface upstream and traps the oncoming sediment load, it is a low dam. Once the reservoir has become filled with sediment, the low dam is a sill. Although now the bed of the stream has been raised upstream, the channel bank heights upstream are less than they were, the division between channel and overbank flow during floods will be changed, and the floodplain will eventually be raised.

If a sill structure is used to raise the streambed, the vulnerability of the bridge is probably increased for some period of time before aggradation has raised the streambed, and the depth of flow at the bridge is greater than it was and the scour at the

piers and abutments is clear-water scour rather than scour by sediment-transporting flow. Both are factors which result in more scour measured from the streambed.

Whether the sill structure is used to raise the streambed, or simply to keep the streambed in place, the scour at the toe of the sill structure must be known if the structure to be designed is to be able to remain and do its job during the floods which could happen. Since the scour at the toe must be measured from the downstream water surface or streambed surface, what could happen to the stream downstream is also important. Indeed, degradation is very likely to be the reason for choosing to build the structure in the first place. These two kinds of streambed erosion are quite different and completely independent -- although the local scour at the toe must be measured from the tailwater elevations determined by the degradation that occurs.

Scour in general and by jets in particular. Rouse [9] made an investigation of scour by a vertical, two-dimensional, clear-water jet in a deep pool of water where the material scoured out deposited immediately downstream in a large dune. He interpreted his results to say that the depth of scour increased indefinitely with the logarithm of time (being also a function of the width of the jet, the initial velocity of flow and the fall velocity of the sediment) and, therefore, that there was no limit to the extent of scour.

This absence of a limit was refuted by logic [10] by pointing out that for the clear-water case, the scour would cease when the flow at the boundary was no longer competent to move the sediment, and for the sediment supply case, when the capacity of the flow to move sediment out of the scour hole became equal to the supply of sediment to the scour hole. For a finite rate of flow there must be some size of scour hole when the appropriate limit would occur -- although the limit would generally be approached asymptotically so the finite limit would only be reached in infinite time.

The limit for the sediment-transporting flow case was easily demonstrated experimentally by digging out a scour hole greater than the limiting hole -- then watching it fill up to the original limiting scour hole. The clear-water scour case could not be so demonstrated. It is important to distinguish between these two cases of scour; unfortunately, some investigators seem to confuse or ignore the fundamental differences. In the sediment-transporting cases of long contractions, and of piers and abutments, it was found [11] that as a first approximation, the depth of scour did not depend on the velocity of flow or the sediment size. This simplified the experiments, the analysis and the application to a considerable degree -- but is an approximation that has not been universally accepted. In the clear-water case of those same geometric situations [12], the velocity of flow and the sediment size in combination were found to be very important. It is interesting to note that most of the discussants of the first ASCE paper on the Iowa experiments cited clear-water scour experiments in disagreeing with the interpretation of the results of the experiments with scour by sediment-transporting flow, and only one person discussed the second ASCE paper on clear-water scour -- and he seemed to appreciate the difference. Strangely, those who insist upon some kind of velocity effect on scour (1) are not clear whether they see the difference between clear-water scour and scour by sediment-transporting flow, and (2) do not analyze the case of the long contraction, the one flow geometry simple enough to be able to describe both flow and sediment transport with some confidence.

It can be useful to divide the jet into several successive parts in order to describe what is happening. First, there is the flow before the jet enters the tailwater pool. This portion of the jet is important to the eventual scour only insofar as it determines the initial conditions of the submerged jet which is the next part of the jet to be considered.

The submerged jet expands primarily due to the turbulent mixing at the large velocity gradient between the jet and the tailwater pool. The flow pattern is like,

but not as simple as, that of the symmetrical two-dimensional jet into an infinite room. Both the finiteness of the tailwater pool and the lack of symmetry are responsible for the differences, especially if the jet flows along a boundary.

The third part of the jet is a continuation of the submerged jet after it has made contact with and then has been turned up by the erodible, scoured-out bed. This is the important portion of the jet; the portion which does the eroding and which transports the eroded material out of the scour hole. The preceding two parts of the jet are important only insofar as they determine the jet characteristics as it makes contact with the erodible boundary. There is then interaction between the jet and the boundary with the jet shaping the boundary by eroding it, and the boundary turning and changing the jet.

The scour experiments of this research project. Two basic geometries of sills were investigated in this project: (1) a vertical wall, and (2) a 1 vertical to 4 horizontal sloping sill. The experiments, the results, and the equations to predict the clear-water scour for each of these geometries were described in Part I and Part II of this report.

For the vertical wall, the prediction equation was:

$$\frac{D_s}{y_c} = 8 \left( \frac{V_c}{w_o} \right)^{3/4} - \frac{6 + \frac{V_c}{w_o}}{\sqrt{1 + \frac{2\Delta WS}{y_c}}} \quad (5)$$

where  $D_s$  is the scour depth measured from the downstream tailwater,

$y_c$  is the critical depth of flow,

$V_c$  is the critical velocity

$w_o$  is the fall velocity of a quartz sphere of median diameter  $d$  of the material being scoured,

$\Delta WS$  is the drop in water surface across the structure.

For the 1V:4H sloping sill, the prediction equation was:

$$\frac{D_s}{y_c} = 4 \left( \frac{y_c}{d} \right)^{0.2} - 3 \left( \frac{d_{rr}}{y_c} \right)^{0.1} \quad (13)$$

where  $D_s$  is the scour depth measured from the downstream tailwater,

$y_c$  is the critical depth of flow,

$d$  is the size of the material being scoured (or the riprap blanket in the bottom of the scour hole),

$d_{rr}$  is the size of the riprap layer protecting the surface of the sloping sill.

These two prediction equations are illustrated graphically in Figures 14 and 15.

Note that the two prediction equations have different dimensionless independent parameters which represent the flow and sediment characteristics that are primarily responsible for the scour. In the case of the vertical wall, the sediment leaves the scour hole in suspension; therefore, the fall velocity of the sediment is the important sediment characteristic, and  $V_c$ , although it is not the velocity of the flow out of the scour hole, it is the reference velocity characteristic of the flow. It should perhaps be emphasized that the fall velocity to be used in the prediction equation is the fall velocity of a quartz sphere of the median sieve diameter at 20°C. If a more correct, or even measured, fall velocity is used, the coefficient would have to be changed. The other parameter accounts for the change in the flow from the brink to the water surface of the tailwater pool.

In the case of the sloping sill, it should be noted that the critical depth represents several flow characteristics, not just a length scale. Although not obviously apparent and readily seen, the critical depth represents a reference velocity, unit discharge, and (together with other variables) boundary shear. The sediment leaves the scour hole at the toe of the sloping sill as bed load; therefore, the sediment

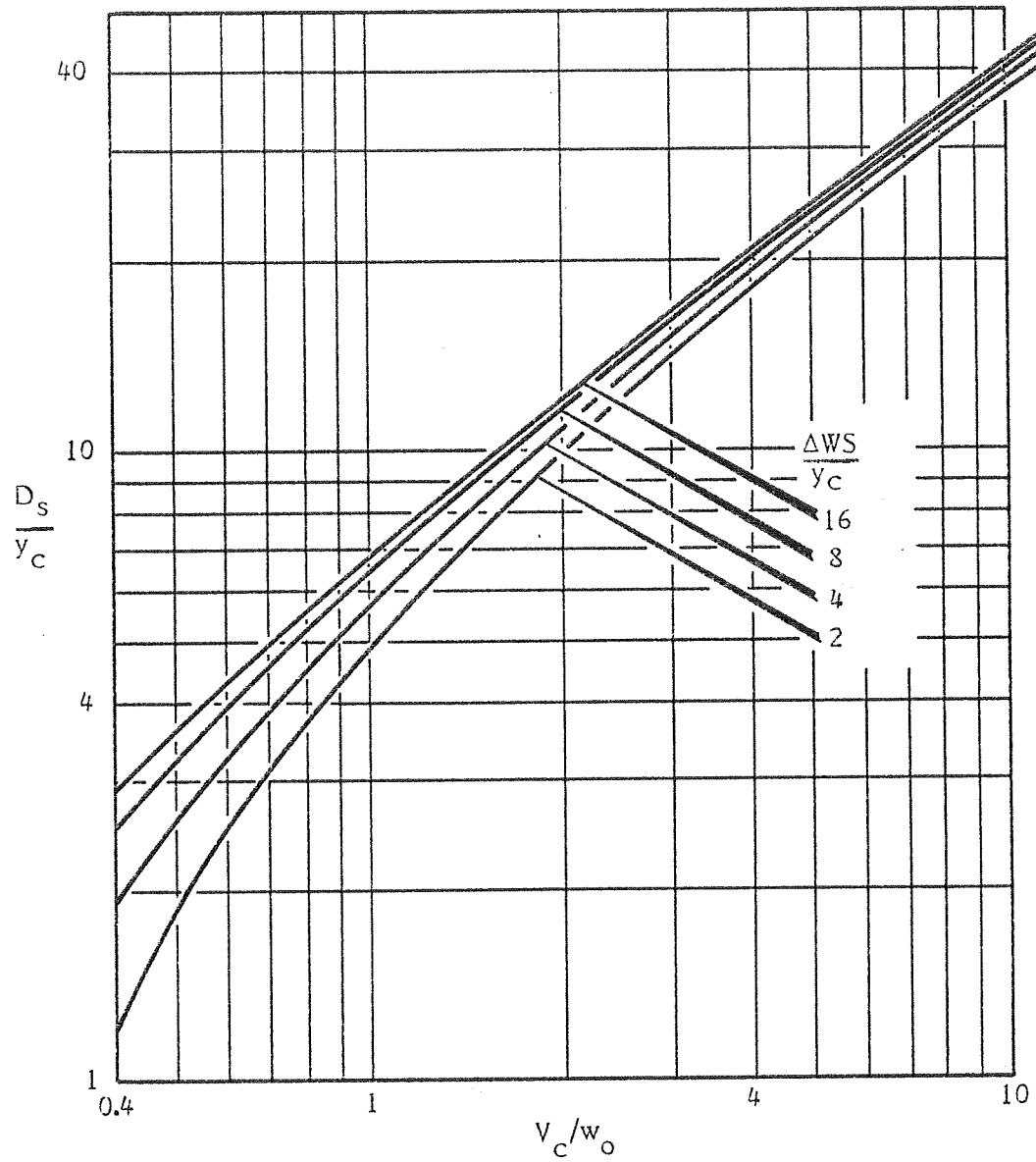

FIGURE 14. Adjusted, Approximate Analytical Scour Relationship for Vertical Wall.

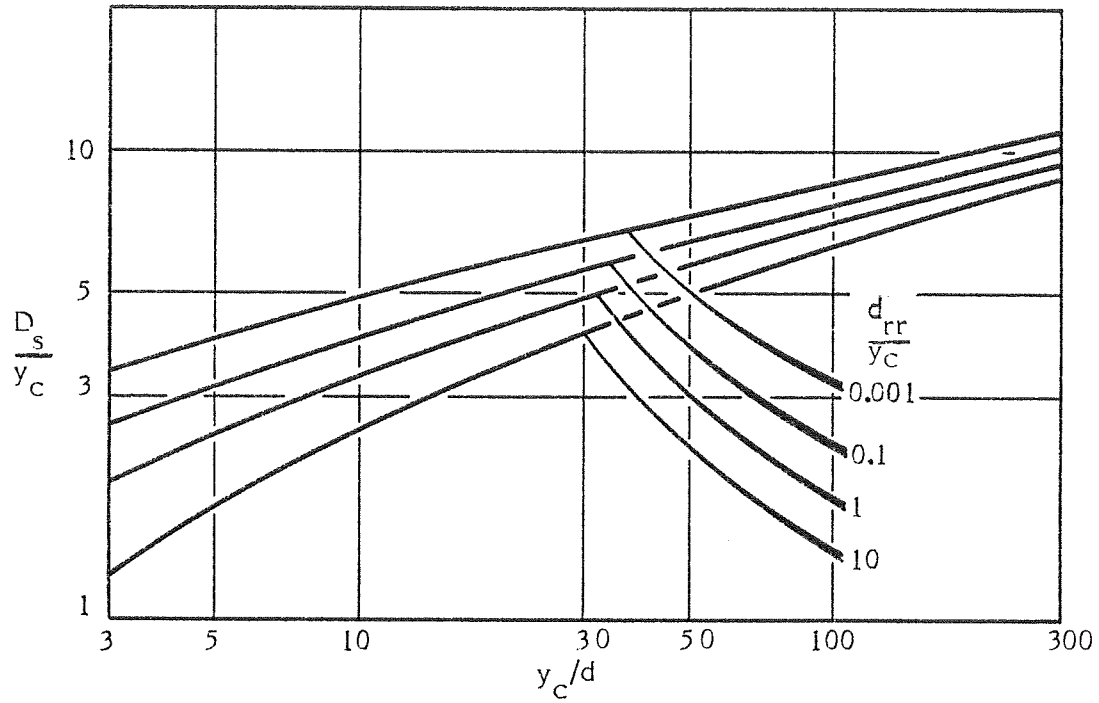

FIGURE 15. Adjusted, Approximate Analytical Scour Relationship for Sloping Sill.

characteristic of importance is the critical tractive force which was taken as simply four times the median diameter. This approximate value should probably be increased for fine material less than 0.1 mm. However, for this fine material, the scour would probably be excessive in any event. Of course, if the very fine sediment is cohesive (ie., clay), the critical tractive force should be increased and would not be a function of diameter as a measure of the ratio of volume to surface area (or a measure of the buoyant weight to the boundary shear force associated with a particle). The drop in water surface did not seem to be an important parameter; the normal depth on the sill slope is a better measure of the character of the flow as it enters the tailwater pool. Although there is a difference in depth of flow between critical and normal depth, using the normal depth makes for a conservative prediction. The ratio of the size of the sill slope riprap to the critical depth expresses this factor.

It should be emphasized that only with a very flat sill slope can the protective riprap practically be large enough to stay by itself. A flat slope, however, would require a large (length, area) volume of protective riprap. A flatter slope would result in a lesser depth of scour (the coefficient would be reduced by the ratio of the sine of the slope angle to the sine of the angle of the IV:4H slope), but the length of slope beneath the tailwater slope should not change appreciably -- however, the length of slope before the tailwater pool would increase. The optimum (least cost) slope will depend on local costs, and the angle of a stable slope which depends on several factors, such as the angle of repose. The optimum is probably seldom very different than a IV:4H slope.

Therefore, it is recommended that the protective riprap be covered with a heavy, galvanized wire mesh anchored into the ground so that the seepage forces and fluid boundary shear cannot move the protective riprap. The protective riprap should be isolated from the underlying material by a sand and gravel inverted filter, or by permeable, long-lasting fabric and a gravel layer. This is to prevent



leaching of the underlying layer through the riprap. The gravel on top of the fabric would be to protect it from rips and from the sunlight. The gravel must be large enough not to be lost by leaching. Riprap which is not anchored to the underlying soil mass must be very large; for a IV:4H slope it should be at least equal to the (energy) critical depth [see the derivation of Eq.(12)].

The choice of size of protective riprap probably depends more on availability and cost than any other factor. The larger the riprap, the less the scour depth, but the greater the volume of riprap per square foot of area. The depth of scour can probably be reduced more economically by riprapping the bottom of the scour hole than by increasing the size of the slope riprap.

It would probably be good practice to have the wire mesh under as well as on top of the riprap -- at least at the edges, and especially at the bottom edge. The two layers of wire mesh should be tied together making a "rock quilt" that could settle, but remain intact. Gabions could also be used, but they also should probably be anchored -- tied to the soil mass below.

For both the vertical wall and the sloping sill there are several considerations which would mean less scour than the maximum clear-water scour depth predicted by the appropriate equation. The flow can be transporting sediment, and if the approach flow supplies sediment at the rate that critical flow would, the depth of scour at the toe of the vertical wall will be 75% of the clear-water prediction, and the depth of scour at the toe of the sloping sill will be 50% of the clear-water prediction.

The peak of the hydrograph can be too short a time to result in the final equilibrium scour being attained. To dig out a scour hole completely takes time. However, 50% of the final scour depth is attained very quickly and 90% of the final scour depth does not take a great, long time. It is only when the equilibrium depth of scour is approached that the capacity to enlarge the scour hole becomes very small and the time needed to scour a little more becomes great.

One difficulty in relying on this time consideration in predicting less scour is that the flood hydrograph as well as the peak flow must be known (estimated).

The other consideration is the riprapping of the bottom of the scour hole either naturally (self-sorting) or artificially. For the sloping sill geometry, this consideration is tantamount to changing (increasing) the size of the sediment to be scoured out. In practice it is recommended that the bottom of the scour hole be artificially riprapped; then the size and extent of the riprap can be controlled and known for sure. If self-sorting is counted on, there is always some doubt about how much of what size of coarse material was available for armouring in the first place, and how much is removed in the active scour process in the second place. Better to know than to guess; besides, most of the eventual scour hole must be excavated in order to construct the sill and if enough (or large enough) coarse material cannot be found, more (or larger) rock can be imported.

At the equilibrium limit of the scour at the toe of a vertical wall, there is still considerable movement of the surface particles -- they are being tossed up into suspension and falling back onto the downstream slope of the scour hole, then slumping back down. The riprap blanket must either be very thick to permit this action and still not uncover the underlying finer sediment, or the scour depth must be increased by 50% to reduce the activity.

It is not proper to expect all these considerations to affect the scour depth in conjunction. They are quite independent considerations. If the hole is riprapped, the fact that the flow is transporting finer material is of no consequence. If the hole is riprapped, any finer material overlying the riprap layer will be removed very quickly. Only in the case of an unriprapped hole and sediment-transporting flow might there be also a time consideration. However, the evidence from field measurements of scour at piers indicates strongly that local scour holes develop so rapidly that equilibrium scour is sensibly attained throughout the scour hydrograph.

For several reasons, the sloping sill would appear to be the preferred geometry: the scour depth is less, the structure is less, and the lower end of the structure can be added to quite simply if need be in the future.

If the dimensionless predicted scour depth is less than about two, the answer is probably unrealistic. The scour depth will be at least a little greater than the downstream tailwater depth. In such a case, it is practically sufficient to assume a nominal scour depth 50% greater than the tailwater depth -- remember that the scour depth is defined herein for this kind of geometry as being measured from the downstream (tailwater) water surface.



## DEGRADATION

Since the purpose of installing a sill structure is either to prevent the permanent lowering of the streambed at some specific section on the river, such as at a bridge, or to raise the streambed at that section, an examination of the degradation phenomena is needed. Although the geological role of the river is to transport the mountain to the sea, bit by bit, and although there is degradation in the upper reaches and aggradation in the lower reaches, this process is seldom of interest because the degradation is too slow to increase the vulnerability of the bridge markedly.

The degradation of interest here is the permanent lowering of the streambed over a considerable distance and occurring over a few years. The reason why it happens can be natural or man-caused; but always the reason is a changed condition. Occasionally, it may be possible to make another change which will result in aggradation; thereby cancelling out the degradation so the elevation of the riverbed remains what it was. More often, such a solution is not feasible.

A long contraction can also result in lowering the bed of the river over a considerable distance. However, a long contraction scours out on the rising leg of the hydrograph and then fills on the recession (there may be a time lag, and various "strange" things might happen if the floods cannot fully scour and fill the entire length of the long contraction). The point is that the lowering of the streambed is not permanent, but in response to the change in the water surface elevation -- or the discharge.

There are other similar fluctuations in the streambed that can take place; usually these are somehow associated with changes in discharge. For example, a tributary in flood can supply a large sediment load to the main stream, resulting in deposition. The main stream can later flood, and be able to remove the previous deposition (i.e., to erode it).

These kinds of fluctuations should be considered forms of general scour at the bridge crossing to which the local scour at the piers and abutments should be added.

Degradation, whether natural or man-caused, will be the result of a permanent change in the flow or boundary conditions, not to fluctuations in discharge resulting in fluctuations of the riverbed elevation. There are two aspects to the problem of predicting or estimating degradation: one is the amount of degradation, the other is the time which will elapse before the degradation results in a new equilibrium. The first is not an easy estimate to make; the second is much more difficult. The saving grace is that the time estimate only needs to be of an order of magnitude. Is the degradation going to endanger the bridge in one year, ten years, or a hundred years? "That is the question." If the answer is something like one year, an emergency measure is needed immediately. If the answer is something like ten years, the remedial measure needs to be put in the budget sometime within the next few years. If the answer is something like a hundred years, it is possible the bridge will be torn down to be replaced by a wider, stronger bridge before anything needs to be done. That still leaves the amount of degradation to be estimated -- and with a greater degree of precision than order of magnitude.

There are a number of changes that can result in degradation, but they all fall into one of three categories: either the slope stays the same, or almost the same, as it always was, or the slope reduces to that of a flow which is no longer competent to move the streambed material, or the slope reduces to less than it was, but greater than that of clear-water flow.

The classic example of the first category is the meander which swings in on itself and cuts off, shortening the river and creating a discontinuity in the bed for a moment. The increased capacity of the flow upstream of the cutoff results

in a headcut which moves upstream. The increased supply to the reach downstream of the cutoff results in deposition in the form of foreset and topset beds. The reach of active erosion and deposition is steeper than the original slope of the stream, but as the reach lengthens, it gradually approaches the original slope.

At the limit, the entire river upstream of the cutoff is lowered half the drop of the discontinuity at the cutoff and the entire river downstream is raised a like amount -- at least as a first approximation. The drop at the discontinuity is equal to the product of the slope of the stream and the length of the meander which is cutoff and abandoned.

This description will be modified a bit if there is floodplain flow because the percent of the total flow in the channel will increase from the normal where the channel is eroded and will decrease from the normal where the channel fills. Another factor which can determine what eventually happens is the condition at the lower end of the river. If the river ends at the sea or by being tributary to another much larger river, it is possible that the water and bed elevations at the lower end will not change appreciably. Under those conditions when the deposition reaches the end of the river, a headcut starts there and moves upstream "erasing" the former deposition and adding to the former erosion so that the amount of degradation above the cutoff is the total drop at the original cutoff.

This description, in turn, can be modified if for every meander that cuts off, a hundred other meanders lengthen by one percent of the length of the meander which was cut off. The overall effect on the river is then nil, but some reaches erode and some reaches deposit. All in all, even this "simple" classic case can become complicated and prediction of degradation difficult.

Another common example of the first category is when the control section for a stream is lowered; i.e., after the main stream degrades above a cutoff, the

tributaries start degrading to match this new control. Except insofar as the division of channel and floodplain flow changes, the slope of each tributary will be what it was.

The classic example of the second category is the dam with a reservoir large enough to trap the incoming sediment load but too small to affect the flow discharge. The flow out of the reservoir is clear water. It has a capacity to transport sediment. It will transport sediment at its capacity (granted that that capacity changes as the bed material changes and the flow characteristics change). Since capacity exceeds supply (which is zero out of the reservoir), degradation occurs starting at the dam and proceeding downstream.

As the bed erodes downstream of the dam and reservoir, the depth of flow increases, the velocity of flow decreases, and the required slope decreases. The new velocity and depth can be estimated from the requirement that the particle shear must equal the critical tractive force of the armoured, self-sorted bed. This estimate can be made, but not easily because the amount of coarse material available for armouring throughout the river is unknown (and unknowable for a modest price). The percentage of coarse material which leaves each reach so that it cannot contribute to armouring is unknown (although what leaves one reach becomes part of the next reach), and the particle shear and critical tractive force are only approximately known. The other factor that must be known, however, is the resistance (or resistance factor; i.e., the Manning  $n$ ) for the armoured bed, which in a real river will not be the same as for a smooth, riprapped, prismatic, man-made channel. The slope, therefore, is not knowable with great precision -- which is unfortunate because the ultimate limit is a river of that unknown slope fixed downstream at some control elevation. As if the above exposition was not discouraging enough, the equilibrium slope for zero movement depends on the discharge as well as the armour layer and resistance coefficient.



In between the limits of zero transport and the same as it was, there is a considerable variety of degradation cases. The classic dam case changes as soon as a tributary joins the main stream and the sediment load which must be carried becomes greater than zero but less than what it was. Whether there is degradation or aggradation below the confluence depends upon how much sediment the tributary adds and how much the flow in the mainstream is controlled (or even decreased if it is an irrigation or water-supply reservoir). The required slope downstream from the confluence is imposed by the flow and sediment load, but isn't really a single value because these variables are not single-valued variables.

The required slope in a stream can be changed by adding to, or subtracting from, the flow of the stream without changing the sediment load; thereby causing aggradation or degradation. If a stream is narrowed, the required slope will be less than it was. If the Manning n value is reduced, the required slope will be less than it was. Blocking off several small streams and combining them to flow through the same cross drainage structure will probably result in degradation of the combined stream downstream. In all of these examples, degradation of the third kind will occur.

It should be apparent that even to predict the limit of degradation is not easy. Some of the things that need to be known to make the prediction are unknown, and likely to stay that way for some time. To be able to say more about how the degradation at a particular section will vary with time means to be able to describe the capacity-supply imbalance with time, which, in turn, means being able to describe the flow characteristics during degradation, the sediment transport, the resistance, and to have knowledge of the sediment in the volume which will be eroded. Then, in addition, the future flow must be known, or else the answer (if it could be computed) would have to be put in terms of "If these flows occur, this degradation will occur."

In practice, it will probably be necessary to observe degradation as it starts and continues (or the conditions that could result in degradation). Then take such remedial measures as seem to be appropriate, with a little conservation. A sill structure could be such a remedial measure. Then continue to observe, and if it seems necessary, remedy the remedial measures. A structure which can be added to or improved at the bottom seems like a "good" solution.

Others interested in degradation for one reason or another seem to have come to much the same conclusion. The Corps of Engineers Streambank Erosion Study [13] mentions degradation as an unsolved problem, mentions sill structures, but provides no guidelines or advice as to how to proceed. A National Academy of Science report [14] on the use of mathematical (computer) models to determine flood levels on alluvial streams which can aggrade and degrade could not advise the use of these more complex and costly computer models. The results were no better than the results from computer programs with rigid boundary channels. The lack of confidence was ascribed to:

- (a) No faith in sediment-transport formulas,
- (b) No reliable values of the friction factor,
- (c) Inadequate understanding of armouring, and
- (d) Inability to include bank widening effects.

Two other recent reports bear titles [15,16] that would indicate the answer to the degradation problems should be contained therein, but only qualitative descriptions of degradation are actually presented. This may make the reader more aware of the problem, but does not help in the solution of the problem.

## SOME HINTS ABOUT SOME OTHER NOT FULLY ANSWERED QUESTIONS

Various student research projects at The University of Arizona have provided the beginnings of some answers to some of the other unanswered questions which surfaced during the study to advance the methodology of assessing the vulnerability of bridges to scour. And, of course, the exploratory research of that project was helpful. The student projects, it should be noted, were at no cost to this project, indeed, they were performed at very little cost to anyone except the students. Their contribution being time and "sweat". A summary of their findings is included herein because they are of use to solving the problem of making bridges less vulnerable.

The first to be cited is an experimental study, at extremely small scale, of riprap in the bottom of a scour hole around a round pier by Marcus [17]. He found that the riprap didn't need to be as large as the previous solution [12] predicted. He found the previous solution could be modified by evaluating  $\tau_c = 7d$  instead of  $\tau_c = 4d$ . This results in riprap sizes about half that which would have been specified previously. This work is important because it provides a more reasonable, alternative remedial measure. Perhaps in some situations it would be better to riprap the pier and abutment scour holes at the lowest possible level, and let the degradation occur. Marcus' work needs to be repeated at a larger scale and expanded in range of geometry, but it seems very promising.

If a smaller, riprapped, scour hole may at times suffice, then a lesser predicted scour depth should be equally interesting -- if the lesser prediction is more correct. Alawi [18] investigated this question in the same small flume later used by Marcus and found the effect of velocity on scour was as analyzed during the early Iowa studies and not as portrayed by the CSU Staff in the training and design manual prepared for FHWA [19] and by Jain and Fischer [20] recently at Iowa. The experimental data and several predictions are shown in Figure 16. At very high velocities (and Froude numbers), the scour did increase somewhat because the sides of the scour hole are

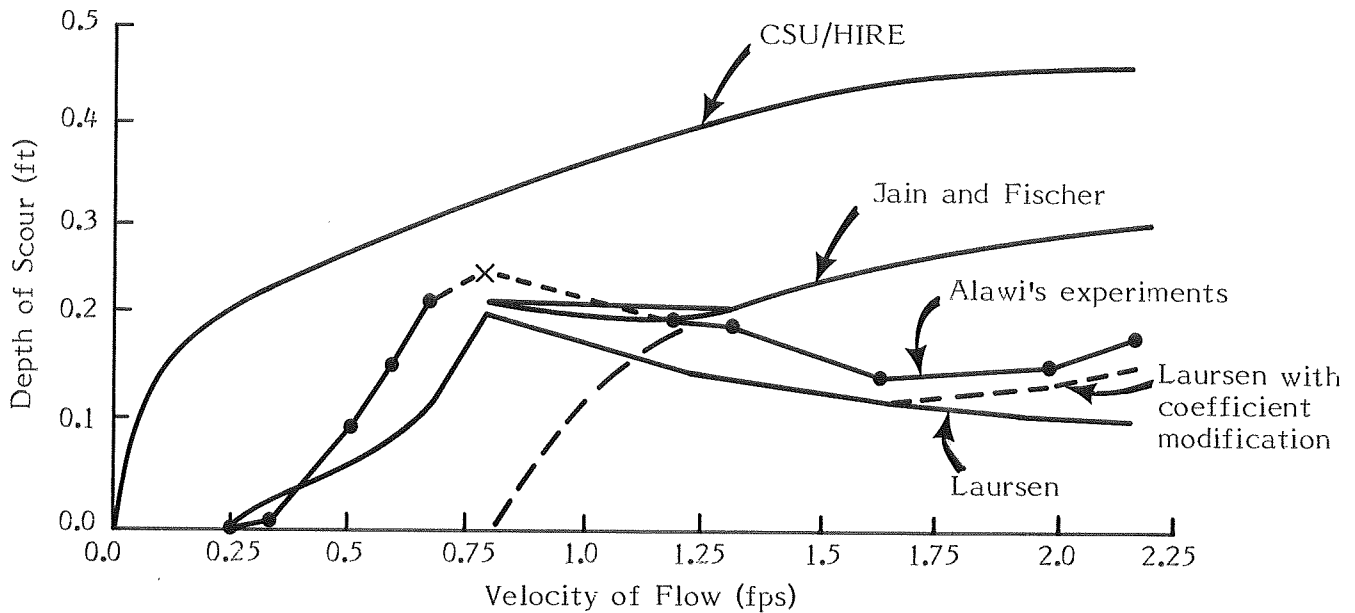

FIGURE 16. Comparison of Various Scour Formulas with Experimental Data.

steeper and less sediment is supplied to the scour hole. If the correct width of scour hole is used, the old analysis still predicts. In Arizona, high Froude numbers are usual and the CSU/HIRE predictions of scour seem to be too high, by twice.

Silverston in an analytical study [21] using the computer, found that for a given discharge, sediment load, bank erodibility, and Manning  $n$ , there was a certain stable width, depth, velocity and slope. The slope was the least well-described of the stable channel characteristics because Silverston could do no better than assume a nominal  $n$  value. However, it should be noted that the slope is also determined by the velocity and depth of flow, and they, in turn, are determined by the discharge and sediment load. The approximate relationships Silverston found resemble the famous, old "regime" equations, but with coefficients and exponents which vary with the sediment concentration and bank erodibility. Tsay [22] used Silverston's relationships to explain observed bank retreat on some of the larger streams in the Tucson area.

All of this work needs to be repeated and expanded to provide more confidence in the predicted channel changes. Channel widening and bank retreat can be very important in connection with bridge vulnerability.

A little, nagging question has been whether a short elliptical pier loses all its "good" shape effect when it is at an angle to the flow. Elhasan [23] investigated this problem and found that the elliptical pier loses most, but not all, of its shape effect. This little experiment illustrated nicely the fact that often the simplest way to answer a question is to run a little experiment.

The same resort to experiment was made several times in the previous ADOT study. To find out what scour to expect with long, thin piers set at an angle so they overlap; as a first approximation the overlapping length can be ignored. To find the scour at a spur dike at an abutment, the deep scour is shifted to the end of the spur dike, the scour is slightly different because the geometry is different, and the tail of the scour hole can endanger the abutment if the spur dike isn't long enough. The effect of scour on backwater is due to the fact that an excess velocity is not developed when scour occurs. The backwater which occurs is only the fraction of the flow obstructed times the approach velocity head. This last finding is of great importance for many different problems.



## APPLICATION

To illustrate the application of these predictions of scour at a sloping sill, consider a bridge worth \$1,500,000 still having a life expectancy of 25 years. The river is 200 feet wide, contained within its banks even for the maximum expected flood of 25,000 cfs with a slope of 0.0064 and a Manning value of 0.03. The 100-year flood is 10,000 cfs; i.e., the maximum expected flood is 2.5 times as large as the 100-year flood.

There is a 16-foot headcut moving upstream towards the bridge which will cause the destruction of the bridge if "something" isn't done very soon. If a sloping sill structure of tied-wire rock, riprap, and railbank is considered, it needs to be examined for the maximum expected flood and the 100-year flood. The comparison is shown in the following tabulation:

### Comparison of Possible Sloping Sill Structures

	<u>100-Year Flood</u>	<u>Maximum Expected Flood</u>
Slope	\$ 70,000	\$142,222
Hole	2,833	8,888
Walls	<u>15,648</u>	<u>77,550</u>
TOTAL	\$ 88,481	\$228,660
Difference in Cost		\$140,179
Probable Loss for 100-Year Flood		\$375,000

If nothing is done and the bridge is destroyed, \$1,500,000 will be lost. The cost of the larger sill for the maximum expected flood is only 15% of the value of the bridge and would be justified. The sill designed only for the 100-year flood costs only 40% of the larger sill; the difference in cost to protect against the largest flood expected instead of the usual, nominal, official (100-year) flood,

is 10% of the value of the bridge. However, the probable loss is  $np \times$  original cost, or 25% of the value of the bridge. Note that  $n$  is the remaining life expectancy, 25 years, and  $p$  is the probability the 100-year flood will be equalled or exceeded in any one year.

These costs were obtained as follows: Assume the tied riprap on the slope costs \$60/cy and is 1.5 ft thick for the 100-year flood, but 2 ft thick for the maximum expected flood, the untied scour hole riprap is \$30/cy and has the same thicknesses, and the railbank costs \$12/sq ft for the 100-year flood, but \$15/sq ft for the maximum expected flood, all costs are in place, not just for materials.

Comparison of Required Sloping Sill Structures

	<u>100-Year Flood</u>	<u>Maximum Expected Flood</u>
Total Discharge	10,000 cfs	25,000 cfs
Unit Discharge	50 cfs/ft	125 cfs/ft
Critical Depth	4.3 ft	7.9 ft
Normal Depth	4.6 ft	7.5 ft

Assume bed material is 0.01 ft (1/8 inch) and protective sill riprap is 1 ft.

$D_s/y_C$	10.9	12.8
$D_s$	47 ft	100 ft

Both of these scour depths are too great. Therefore, plan to riprap scour hole with 1-foot untied rock.

$D_s/y_C$	2.8	3.6
$D_s$ (from water surface)	12.0 ft	28.4 ft
$d_s$ (from bed level)	7.5 ft	20.5 ft

These scour depths are practicable and will serve for the desired illustration and comparison. The scour depth, the water surface drop, the slope and the bank height result in the costs estimated.



Note that even the total cost of the sill designed for the maximum flood costs less than the weighted loss of just the bridge in a flood larger than the 100-year flood. When the situation is examined in this way, it is so often true that the 100-year rule is just not good enough.

Looking at the costs of the different elements of the sill, it is apparent that the riprap in the scour hole is the least cost, and the cost of protecting the slope is the greatest. With better relative values of unit costs, including cost of different diameter riprap, it should be possible to optimize the cost of the sill structure. If 2-foot diameter riprap was used, the cost of that riprap would increase, but the cost of the slope protection and of the walls would decrease.

There are those who would increase the cost of construction by a capital recovery factor -- the cost of borrowing money. In a pay-as-you-go system, it can be argued that such a cost is not incurred. However, if it must be (justifiably or not) then it should be the appropriate interest rate in a noninflationary world (about 2-1/2%), or the value of the bridge must be inflated over time to account for the rate of inflation.

An annualized risk analysis is shown below for rates of interest from 0% to 10% in a noninflationary world. The alternatives considered are:

Alternative 1 - do nothing

Alternative 2 - design for 100-year flood

Alternative 3 - design for maximum flood

It is assumed that if nothing is done, the bridge will fail in a ten-year flood. As the example is stated, if nothing is done the bridge will fail soon, and this nominal probability is sufficient to demonstrate that something should be done. It is further assumed that even if the sill is designed for the maximum expected flood, there is some small probability that it will fail -- say the same as the probability of the occurrence of the 5000-year flood. Further, the assumption is made that the only loss is that of the bridge. Even if the cost of preventing the

loss of the bridge turns out to be equal to the probable loss considering the bridge alone, it would be wise to prevent the loss of the bridge because of other losses that would be incurred: removal of failed bridge, accidents, traffic delay. Depending on the particular bridge, the latter two losses can be quite large.

As analyzed below, the best solution would be the design for the maximum expected flood until the interest rises to 10%. Actually, if the interest rate was anything near 10%, the world would be inflationary and the value of the bridge would be increasing every year, tipping the scales to the design for the maximum expected flood.

ANNUALIZED RISK ANALYSIS

Alternate	<u>1</u>	<u>2</u>	<u>3</u>
Cost of protection	0	\$ 88,000	\$ 228,000
	<u>Interest rate</u>		
Annual Costs	0%	3,520	9,120
	2%	4,507	11,678
	4%	5,633	14,594
	6%	6,884	17,836
	8%	8,244	21,359
	10%	9,695	24,118
Value of Bridge	\$1,500,000	\$1,500,000	\$1,500,000
Flood frequency resulting in failure	assumed 10-year RI	100-year RI	assumed 5,000-year RI
Probability of loss in any given year	0.1	0.01	0.0002
Annual risk	150,000	15,000	300
	<u>Interest rate</u>		
Total annual expected cost	0%	\$ 150,000	\$ 9,420
	2%	150,000	11,978
	4%	150,000	14,894
	6%	150,000	18,136
	8%	150,000	21,659
	10%	150,000	25,418

## CONCLUSIONS AND RECOMMENDATIONS

Nature has a way of reminding us every so often that the unusual should not be unexpected. Record floods can occur on the same river in successive years; hundred-year events can occur independently at more than one location within a state in a single year. The design process should consider at least briefly the full array of possible floods. Can the structure, or project, be designed such that operations are suspended or curtailed, during most, or some floods, but so the structure will not be destroyed or heavily damaged? If so, one kind of design may be best. If not, another kind of design may be necessary.

If operations should not be interrupted except under truly unusual, unexpected circumstances, the design should be for the maximum flood. If an operating facility is desirable, but only at the right price, the cost and probable loss for an array of rare floods should be examined in more detail. The answer is likely to be to design for the maximum expected flood, but not necessarily. The details of the cost breakdown for the optimum frequency design should be examined to isolate the parts that contribute the most to the cost. Then questions can be asked about how those costs might be reduced.

If the project is a highway crossing which is threatened by degradation of the stream being crossed, it appears on the basis of this study that a sloping, tied-rock sill would usually be the preferred solution with the resulting scour hole at the toe riprapped to reduce the depth of scour.

In the course of this study, notice was taken of the need (1) to anchor the riprap protecting the sill slope, (2) to round the brink to relieve the vulnerability of those stones, and (3) to construct the sill as "plane" as possible to avoid locally increased scour. A design detail beyond the scope of this study would be layout to preclude the outflanking of the sill structure. If the stream can somehow "get around" the sill structure, the structure cannot serve its purpose.

One obvious phenomenon that can lead to out-flanking is stream widening or bank retreat. The simplest way to counter this danger is to place the sill structure immediately downstream of the bridge and tie it to the bridge. This leaves the problem of the possible changed approach conditions at the bridge and what they mean to the adequacy of the bridge foundation design. However, this is another problem; one which would exist even if there was not degradation and a sill structure.

It is recommended that there be continuation of the cooperation between designers and researchers to find solutions to design details as problems arise as a result of trying to apply these research findings. Things have to be made simple in the laboratory in order to discover principles; things cannot be made simple in the field and questions arise which were not realized in the research effort.

In some situations, riprapping around the piers and abutments, and other protection of the abutments might be a less costly alternative to a sill structure. The amount of degradation expected and the depth of the pier and abutment foundations would be the factors which would dictate one solution or the other. The exploratory work of Marcus suggesting that smaller riprap would be effective needs to be investigated further. The high velocities of Arizona streams seems to require very large riprap. If riprap half that previously predicted is sufficient, the riprap option would be much more feasible, and when feasible, might be much less costly.

## REFERENCES

1. Laursen, E. M. and Toch, A., "Scour Around Bridge Piers and Abutments", Iowa Highway Research Board Bulletin No. 4, 1956.
2. Laursen, E. M., "Scour at Bridge Crossings", Iowa Highway Research Board Bulletin No. 8, 1958.
3. Jones, G. D., "Scour at Bridge Waterways", National Cooperative Highway Research Program Synthesis of Highway Practice 5, NAS/NAE, 1970.
4. Laursen, E. M., "Bridge Design Considering Scour and Risk", Transportation Engineering Journal, ASCE, Vol. 96, No. TE2, May 1970.
5. Laursen, E. M. and Duffy, D. M., "A Study to Advance the Methodology of Assessing the Vulnerability of Bridges to Floods", Final Report, Engineering Experiment Station, College of Engineering, The University of Arizona, Tucson, Arizona, February 1980.
6. Corry, M. L., Jones, J. S., and Thompson, P. L., "The Design of Encroachments on Flood Plains Using Risk Analysis", Hydraulic Engineering Circular No. 17, FHWA/U.S.DOT, October 1980.
7. Rouse, H., "Seven Exploratory Studies in Hydraulics", Journal of the Hydraulics Division ASCE, Vol. 82, No. H64, August 1956.
8. Albertson, M. L., Y. B. Dia, R. A. Jensen, and H. Rouse "Diffusion of Submerged Jets", Transactions ASCE, Vol. 115, 1950.
9. Rouse, H., "Criteria for Similarity in the Transportation of Sediment", Proceedings Hydraulics Conference, University of Iowa Studies in Engineering, Bulletin 20, 1940.
10. Laursen, E. M., "Observations on the Nature of Scour", Proceedings, Fifth Iowa Hydraulics Conference, University of Iowa Studies in Engineering, Bulletin 34, 1952.
11. Laursen, E. M., "Scour at Bridge Crossings", Journal of the Hydraulics Division, ASCE, Vol. 86, No. HY2, February 1960.
12. Laursen, E. M., "An Analysis of Relief Bridge Scour", Journal of the Hydraulics Division, ASCE, Vol. 89, No. HY3, May 1963.
13. U.S. Army Corps of Engineers, Final Report of Congress, The Streambank Erosion Control Evaluation and Demonstration Act of 1974, Section 32, Public Law 93-251, December 1981.
14. Committee on Hydrodynamic Computer Models for Flood Insurance Studies, An Evaluation of Flood-Level Prediction Using Alluvial-River Models, National Academy Press, Washington, D.C., 1983.
15. Shen, H. W., Schumm, S. A., Nelson, J. D., Dohring, D. O., Skinner, M. M. and Smith, G. L., "Methods for Assessment of Stream-Related Hazards to Highways and Bridges", Report No. FHWA/RD-80/160, Colorado State University Engineering Research Center, March 1981.

16. Keefer, T. N., McQuivey, R. S. and Simons, D. B., "Stream Channel Aggradation and Degradation: Causes and Consequences to Highways", Interim Report No. FHWA/RD-80/038, June 1980.
17. Marcus, K. B., "Detemination of the Size and Depth of Gravel Used in a Riprap Layer Around a Circular Pier", CE 900 Report, Department of Civil Engineering and Engineering Mechanic, The University of Arizona, August 1983.
18. Alawi, A. J., "Effect of Velocity on Scour", M.S. Thesis, Department of Civil Engineering and Engineering Mechanics, The University of Arizona, 1981.
19. Richardson, E. V., et al., Highways in the River Environment: Hydraulic and Environmental Design Considerations, Federal Highway Administration Training and Design Manual, May 1975.
20. Jain, S. C., and Fischer, E. E., "Scour Around Circular Bridge Piers at High Froude Numbers", Report No. FHWA/RD-79/104, April 1979.
21. Silverston, E., "The Stable Channel as Shaped to Flow and Sediment", Ph.D. Dissertation, Department of Civil Engineering and Engineering Mechanics, The University of Arizona, 1981.
22. Tsay, K. D., "The Lateral Retreat of Banks on Arizona Streams", M.S. Thesis, Department of Civil Engineering and Engineering Mechanics, The University of Arizona, 1983.
23. Elhasan, A., "The Effect of Pier Shape and Angle of Attack on the Relative Depth of Scour", CE 300 Report, Department of Civil Engineering and Engineering Mechanics, The University of Arizona, May 1983.