

Sharing the Road with Pedestrians

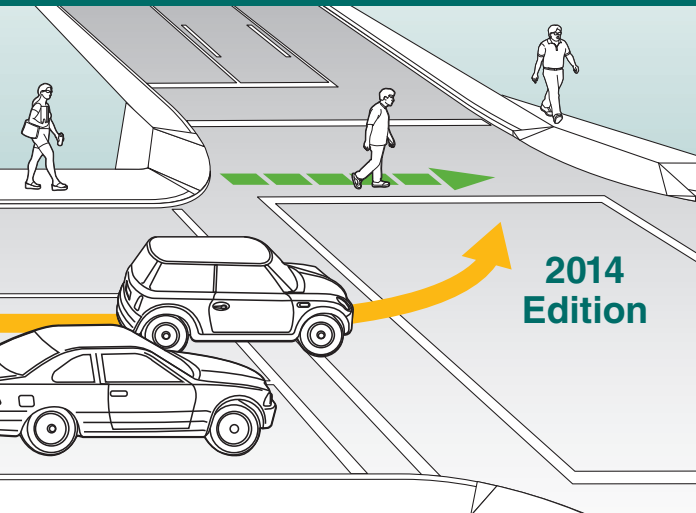

**2014
Edition**

ADOT

A guide for motorists and
pedestrians published by the
Arizona Department of Transportation



Tips for Sharing the Road Legally and Safely

This pocket guide illustrates how pedestrians and motorists can “Share the Road” legally and safely within Arizona.

Please read through these safety tips to better understand the other person’s view of the road and to learn more about walking and driving safely in our great state. The more we understand each other’s needs, the better we can respect and cooperate with each other on the streets.

This second edition of the pedestrian and motorist pocket guide is brought to you by the Arizona Department of Transportation Bicycle and Pedestrian Program.

© Copyright 2014. Produced by the Pima County Bicycle and Pedestrian Program, Matthew Zoll, Program Manager. Design and illustration by David Burnham, Pima County Graphics.

Please refer to pages 34 through 41 for a listing of relevant Arizona Revised Statutes (A.R.S.) pertaining to pedestrian and motorist rights and duties.

Prevent Children from Dashing Out into Traffic

Children ages 5 to 9 have the **highest** risk of all pedestrians of being hit by a car, primarily due to dashing out into the street.

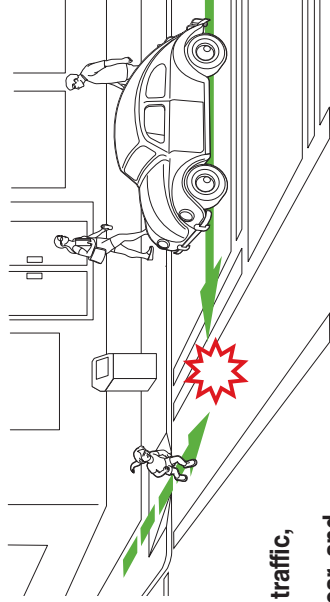

Teach your children to:

- **stop at the curb,**
- **look left - right - left for traffic,**
- **cross only when it is clear, and**
- **keep looking for cars as you cross.**

Watch for Merging or Speeding Vehicles

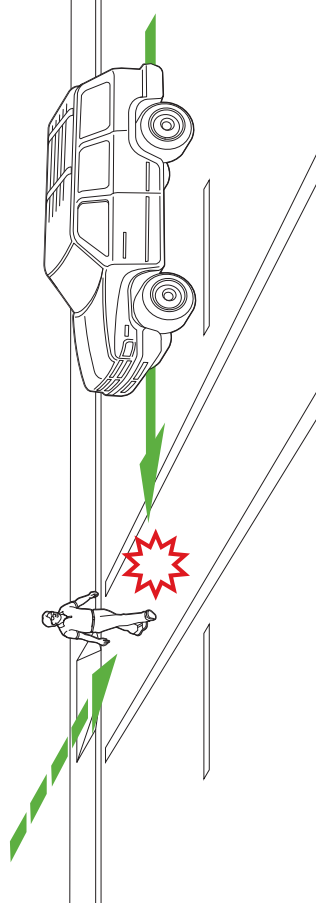

The roadway may appear clear, but suddenly a vehicle may appear where you don't expect it.

Cross with your children at intersections whenever possible. Try to cross at the best location where you have the longest distance to be able to see oncoming drivers and for drivers to be able to see you.

Be Safe Around School Buses

Practice these rules with your child for staying safe around a school bus:

- Stand at least three giant steps away from the edge of the road and line up away from the street.
- Wait until the bus stops, the door opens, and the driver says it is okay to get on.
- To cross the street in front of the bus, walk five giant steps ahead of the bus before you cross. Be sure you and the bus driver can see each other.
- **NEVER** walk behind the bus.
- If you drop something near or under the bus, tell the driver. Never try to pick it up. The driver may not see you and begin to drive away.

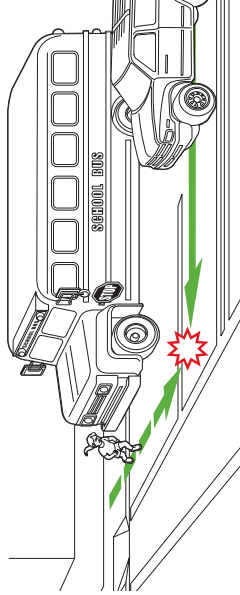

Always Assume that Drivers May Not Stop

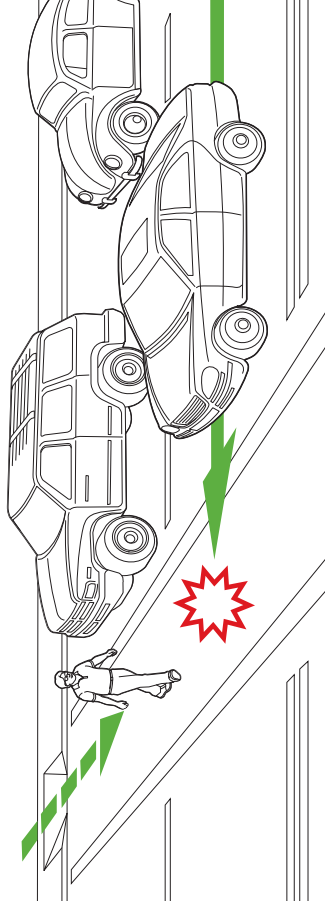

A marked crosswalk does not assure your safety. Make sure that all vehicles are stopped before crossing each lane.

This is extremely important to teach your children. Teach them that **each lane** must be stopped before crossing.

Watch for Turning Vehicles

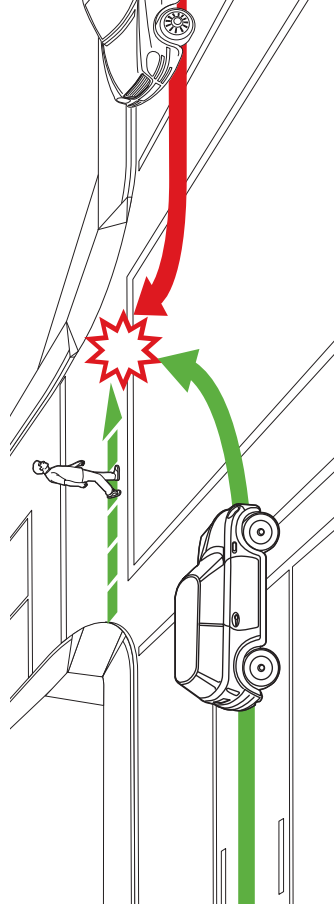

Many times, a turning driver is looking at oncoming traffic and may not see you until he is actually making the turn. Scan over your shoulder as you are crossing the street. Children are often unaware of this condition and must be trained carefully to watch for turning drivers.

Watch for Cars When Crossing Driveways

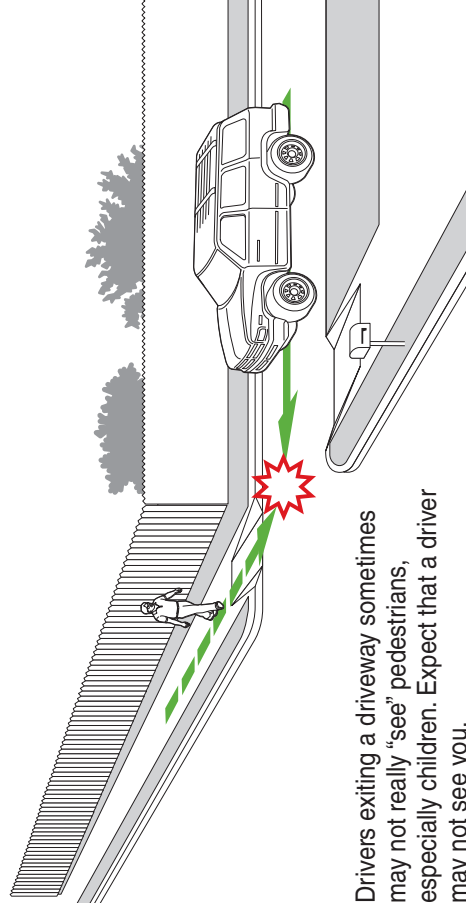

Drivers exiting a driveway sometimes may not really "see" pedestrians, especially children. Expect that a driver may not see you.

This is a major concern in commercial as well as residential areas. Teach your children to be especially careful when on or near driveways.

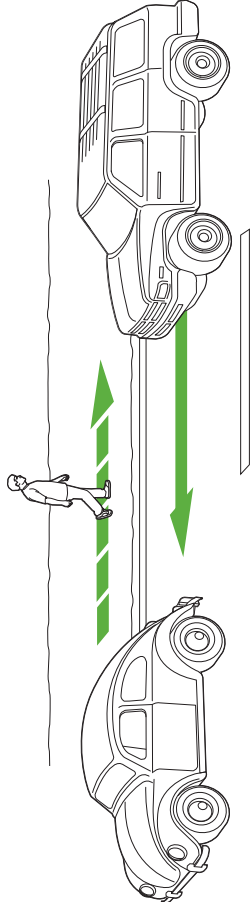

Be Visible to Motorists

On roadways without sidewalks, walk facing traffic whenever possible and at night wear bright colored reflective clothing and carry lights.

Make sure you and your children are as visible as possible.

REMEMBER: Drivers do their best to avoid you if they can see you!

Parking Lots Can Be Hazardous

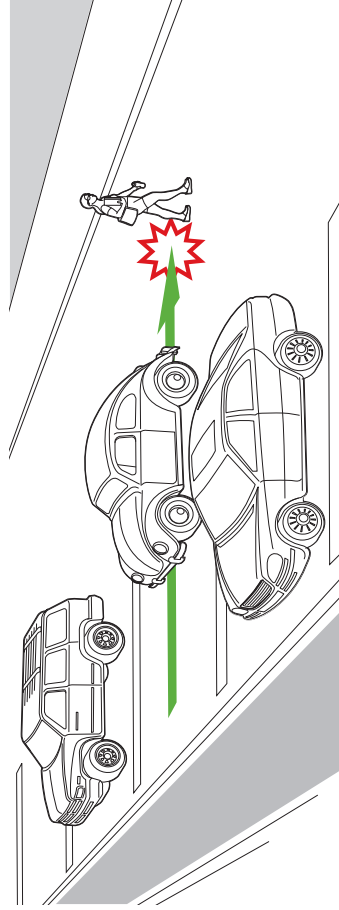

Be aware of traffic at all times, and mind your children carefully. Try to exit parking lots as soon as possible, or walk along the edges.

Keep control of your children in parking lots at all times, as they can be very difficult for drivers to see. Don't allow them to run or play in parking lots.

Runners Should Use the Same Guidelines as Walkers

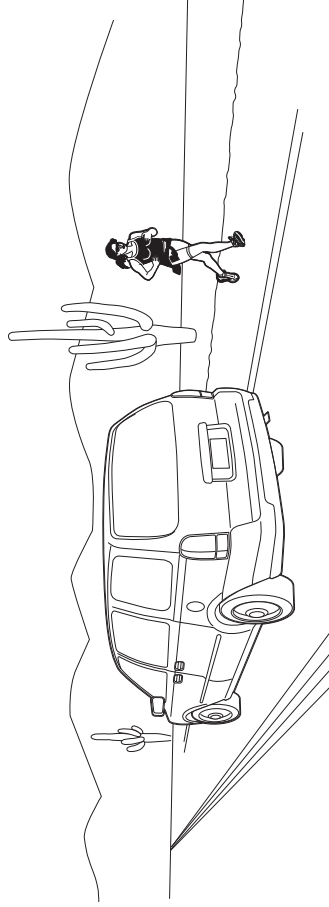

When possible, run against traffic where there are no sidewalks. Don't dart out when crossing the roadway. Be extra alert because you could be moving at a faster pace than motorists expect.

Stay alert! Keep your attention on the road and traffic in front of you. Don't assume that motorists see you.

Tips for Walking in Rural Areas

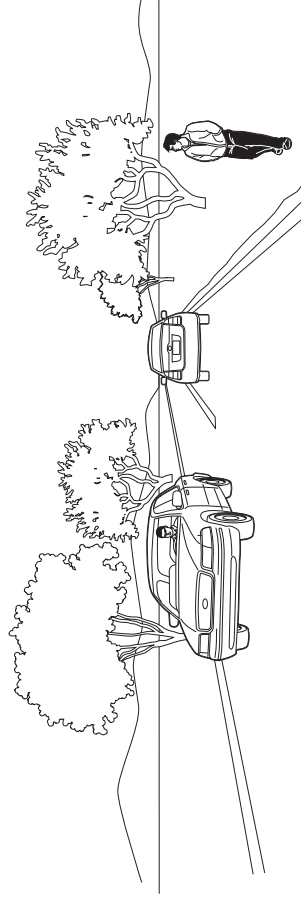

Walk facing oncoming traffic and stay as far off the roadway as possible.

Remember that at dusk or dawn when the sun is low, drivers may not see you.

Wear bright colored and reflective clothing that contrasts with the surroundings. Carry a flashlight in low light conditions but don't aim it directly at motorists.

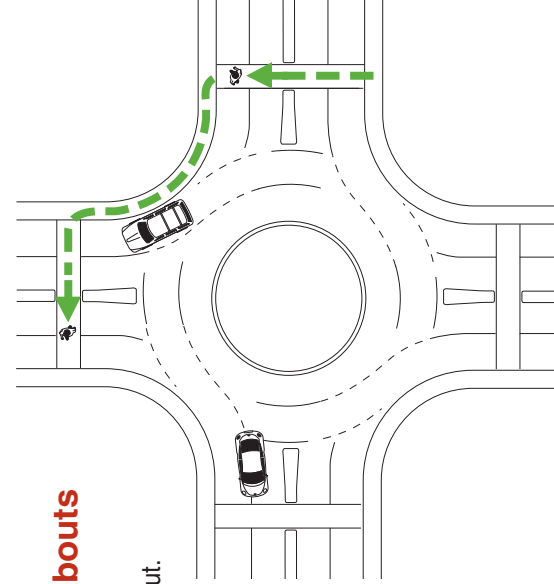

Use Crosswalks to Get Across Roundabouts

Use pedestrian crossings to cross roadways in a roundabout.

Look left before crossing to median island; look right before crossing to opposite sidewalk.

At roundabouts with two entering and exiting lanes make sure each lane of traffic is stopped before crossing.

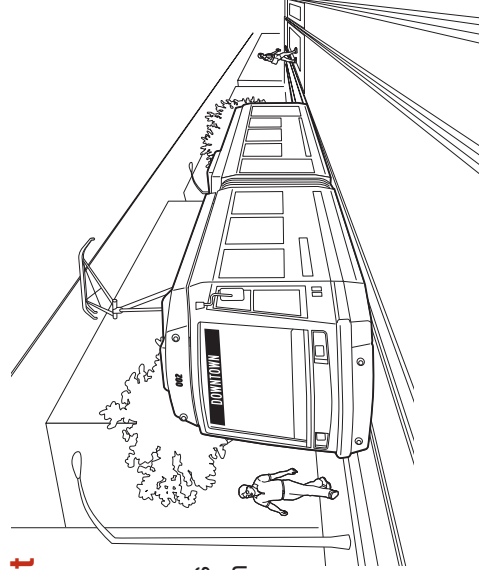

Be Alert Around Light Rail and Streetcars

- Don't walk or stand on the tracks.
- Use the pedestrian walkways and crosswalks. Pay attention to and obey the crosswalk countdown signals.
- Light rail and streetcars are quiet. Listen for warning bells and look for headlights.
- Adults should hold children's hands near tracks and on platforms.
- Keep volume low on headphones, so that you are aware of your surroundings.
- Always stand behind the textured strips on platforms.

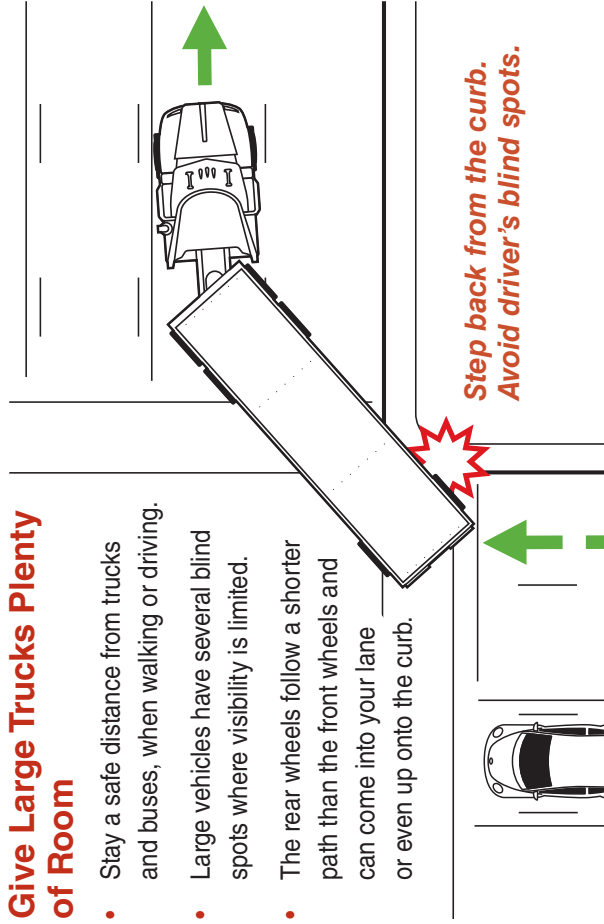

Give Large Trucks Plenty of Room

- Stay a safe distance from trucks and buses, when walking or driving.
- Large vehicles have several blind spots where visibility is limited.
- The rear wheels follow a shorter path than the front wheels and can come into your lane or even up onto the curb.

**Step back from the curb.
Avoid driver's blind spots.**

Pay Attention and Be Aware of Your Surroundings

Headphones and cell phones cause distraction and reduce your ability to hear traffic, which could cost you your life.

Your ears are your first line of defense when walking or running near traffic.



Watch for Children Dashing Out into Traffic

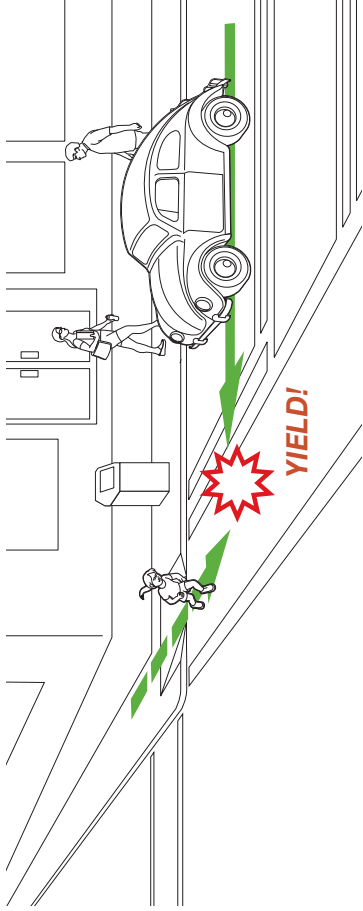

Remember that children may play in or near a street and may often enter the street unexpectedly. Children commonly dash out into the street without looking for cars or without judging distances correctly to oncoming cars.

Please slow down and be ready to stop.

Yield to Pedestrians at Marked and Unmarked Crosswalks

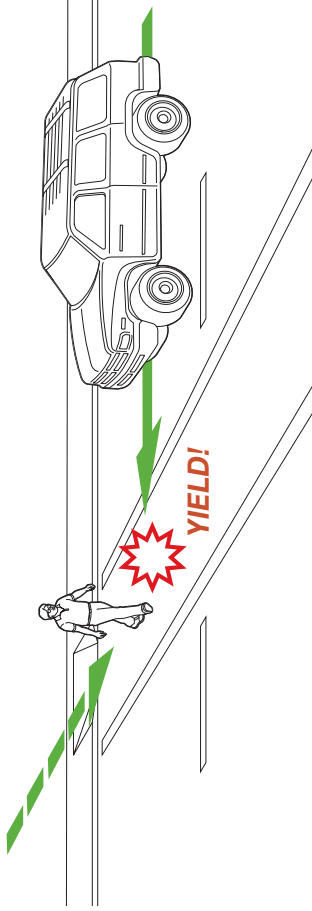

Pedestrians have the legal right to cross a roadway at and between almost all intersections. Drivers must yield to pedestrians at all marked and unmarked crosswalks.

On multi-lane roadways, if you come too close to a pedestrian, you may block the next driver from seeing the pedestrian as he or she is crossing the roadway.

Yield to Visually Impaired People

Tips to help drivers with visually impaired pedestrians:

- If a pedestrian is waiting, stop your car at about five feet from a crosswalk or at the marked 'stop bar'.
- Don't stop your car more than five feet from the crosswalk. A blind pedestrian uses the sound of your engine as a guide, so pull up to the crosswalk to allow the person to hear you.
- Don't give a blind pedestrian verbal directions. The blind pedestrian listens to all traffic sounds before deciding to cross the street.
- Don't wait too long for a blind pedestrian to cross the street. If the person steps back and pulls in his or her cane, it's a definite sign you should go.
- Look for any pedestrian or other traffic before starting your left or right turn. Don't turn right on red without looking right first.

- Don't stop in the middle of a crosswalk. This forces the blind pedestrian to walk around your car and into traffic outside of the crosswalk.

- Don't honk at a blind person. The blind person has no idea who you're honking at and may be scared by the noise.

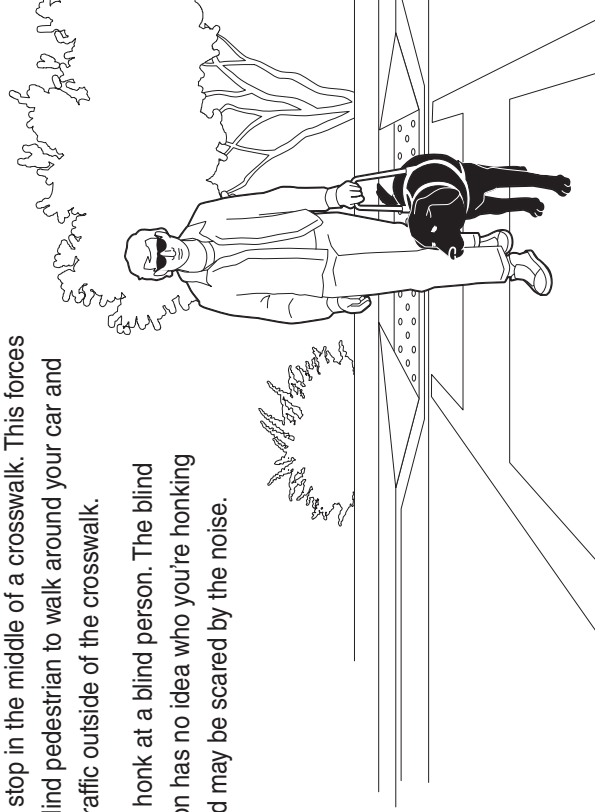

Always Stop for School Buses with Lights Flashing

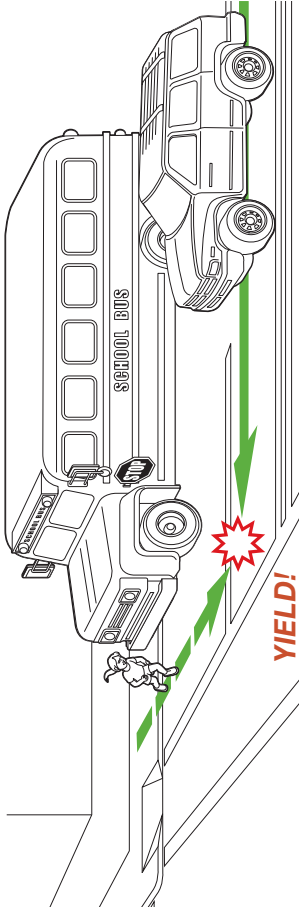

Always expect children to be around stopped school buses, even if the red lights of the bus are not flashing. It is against the law to pass a stopped school bus with its lights flashing (A.R.S. 28-857).

Please slow to a safe speed and look for children.

Don't Pass Vehicles Stopped at Crosswalks

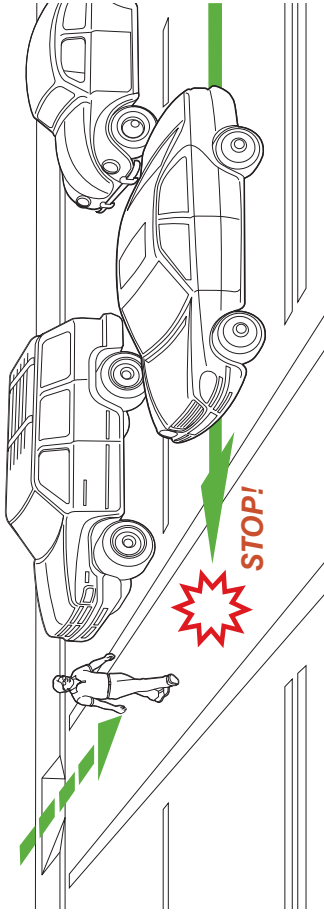

Exercise extreme caution when coming up alongside stopped or stopping vehicles, and be prepared to stop for pedestrians who are walking in marked or unmarked crosswalks.

It is against the law to pass a vehicle stopped at a crosswalk (A.R.S. 28-792).

Yield to Pedestrians When Making Turns

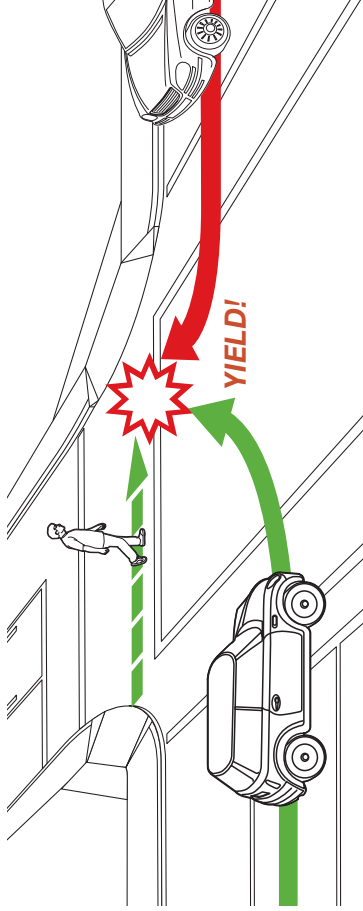

MAKING LEFT TURNS: Always be on the lookout for pedestrians, and scan crosswalks before turning. Be aware that your windshield may partially block your view, so make sure the crosswalk is clear before turning.

MAKING RIGHT TURNS: Yield to pedestrians in the crosswalk. Where not prohibited by signs at a red light, a right turn may be made after coming to a complete stop, when motor traffic and pedestrian traffic are clear.

Exit Driveways Slowly and Carefully

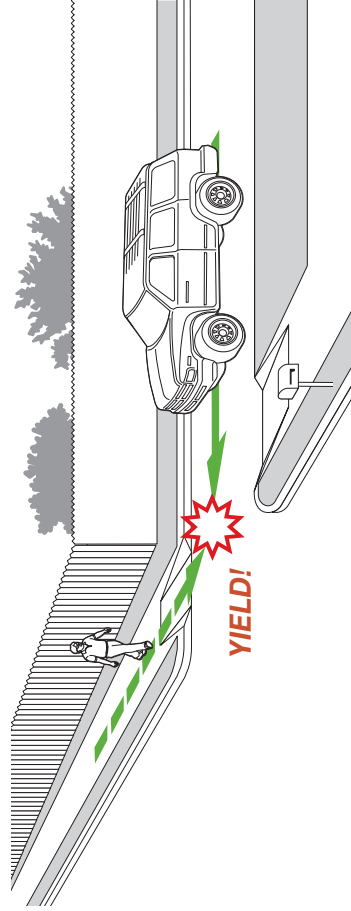

Please avoid rushing into or out of driveways. Expect pedestrians on the sidewalk, especially around schools, commercial areas and neighborhoods.

Also, be mindful in commercial areas, where pedestrians should commonly be expected.

Look both ways for pedestrians before turning onto the street.

Watch for Pedestrians Walking Along the Roadway

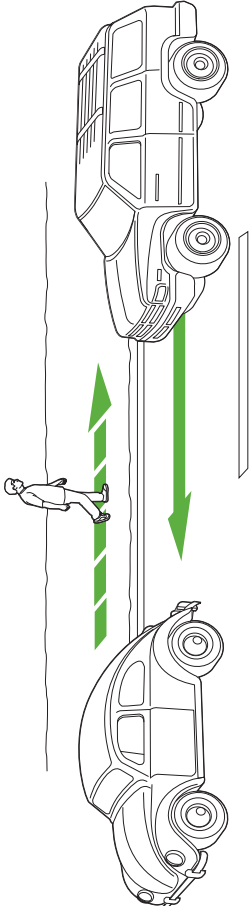

Watch for pedestrians or runners who may be walking or running along a roadway that does not have sidewalks. Remember that they have the legal right to walk or run on the edge of the roadway and that you must yield and avoid colliding with them. (A.R.S. 28-796).

Yield to Pedestrians in Parking Lots

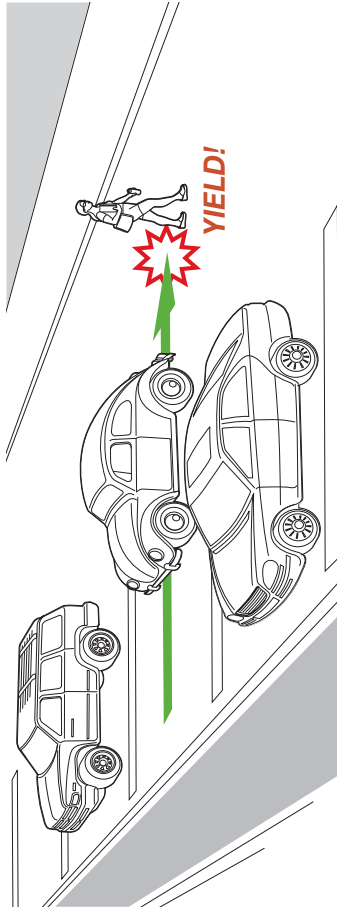

Just as you would hope that other drivers watch for you as you're walking in a parking lot, be very aware and careful around pedestrians as you're driving in a lot.

Remember that a 3,000 pound vehicle can do a lot of damage even at only 5 miles per hour.

Yield to Pedestrians in Roundabouts

When approaching a roundabout, reduce your speed.

Yield to pedestrians in the crosswalk; they have the right-of-way.

When entering, yield to vehicles in the roundabout. Wait for a gap in traffic and merge into roundabout traffic.

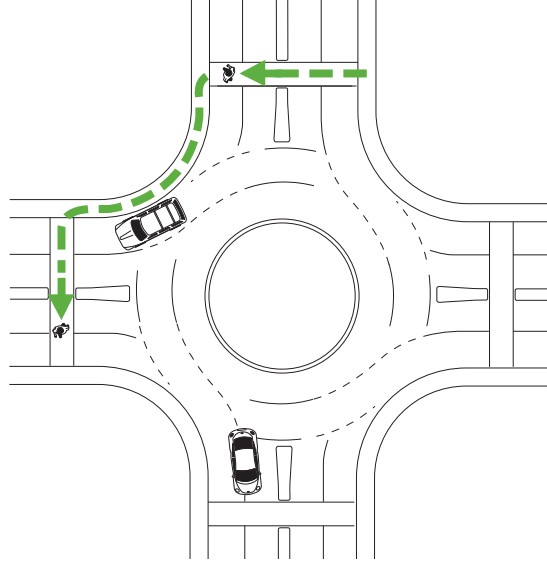

Drivers Must Exercise Due Care

28-794. Drivers to exercise due care

Arizona law requires drivers to exercise due care to avoid colliding with a pedestrian (A.R.S. 28-794). You can do this by:

1. Clearly communicating to pedestrians by using your turn signals any time you are changing lanes or turning at an intersection.
2. Sounding the horn when absolutely necessary.
3. Being extra careful when you see children, or a confused or incapacitated person in the roadway.

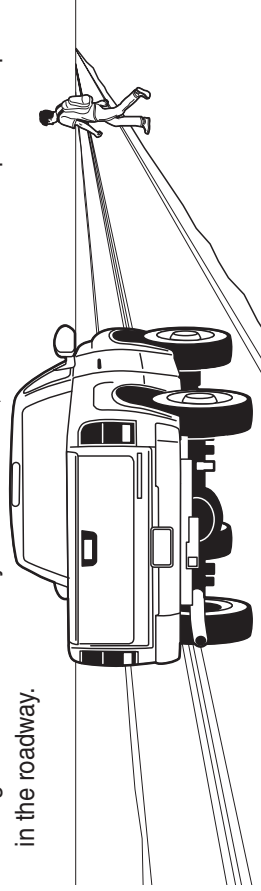

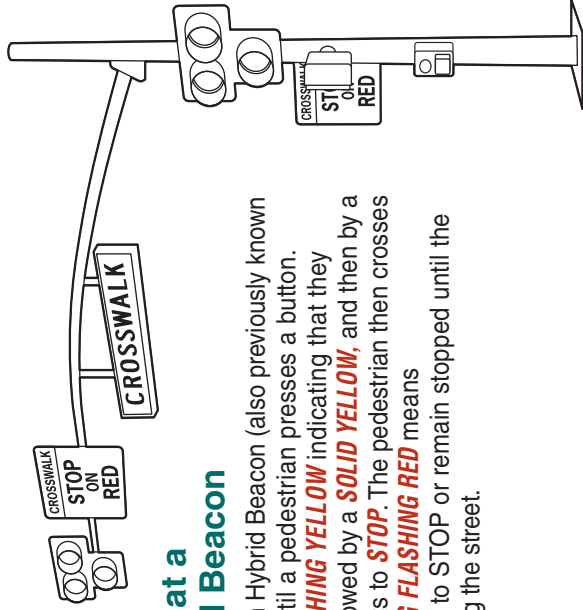

Obey the Signals at a Pedestrian Hybrid Beacon

The signals at a Pedestrian Hybrid Beacon (also previously known as a HAWK) remain off until a pedestrian presses a button. Motorists then see a **FLASHING YELLOW** indicating that they should prepare to stop, followed by a **SOLID YELLOW**, and then by a solid **RED** requiring motorists to **STOP**. The pedestrian then crosses the street. An **ALTERNATING FLASHING RED** means that motorists are required to STOP or remain stopped until the pedestrian finishes crossing the street.

Slow Down in School Zones

- School zones are located on streets where there is a designated school crossing. Cross-walks are painted yellow in school zones.
- When school zone signs are posted, the speed limit is 15 mph between portable signs.
- Drivers are not allowed to enter a school crosswalk if there is a pedestrian in any part of the crosswalk.
- Motorists cannot pass other vehicles in a school zone.
- Motorists cannot park on either side of a school crosswalk.

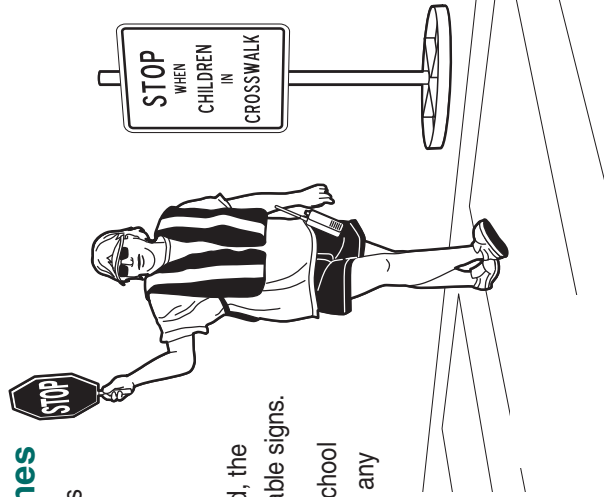

Slow Down When Pedestrians are Present

- Speeding greatly increases the chances of injury if a pedestrian and a car are involved in a collision.

Vehicle Impact Speed and Pedestrian Injury Severity

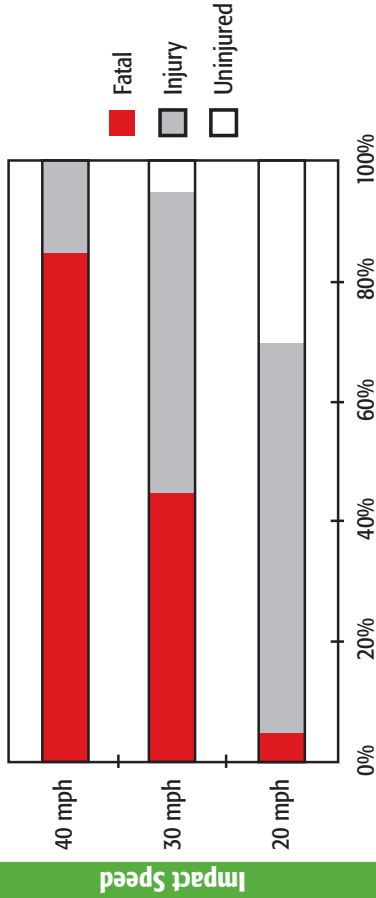

Percentage of crashes with pedestrians that are fatal

Pay Attention to the Road, Not Your Phone

Never text while driving. Texting while driving can take your focus off of the road. It is dangerous and illegal.



Relevant Pedestrian Statutes

Arizona Revised Statutes as of June 14, 2013

28-101. Definitions

“**Pedestrian**” means any person afoot. A person who uses an electric personal assistive mobility device or a manual or motorized wheelchair is considered a pedestrian unless the manual wheelchair qualifies as a bicycle. For the purposes of this paragraph, “motorized wheelchair” means a self-propelled wheelchair that is used by a person for mobility.

“**Electric personal assistive mobility device**” means a self-balancing two non-tandem wheeled device with an electric propulsion system that limits the maximum speed of the device to fifteen miles per hour or less and that is designed to transport only one person.

28-601. Definitions

“**Crosswalk**” means:

- (a) That part of a roadway at an intersection included within the prolongations or connections of the lateral lines of the sidewalks on opposite sides of the highway measured from the curbs or, in absence of curbs, from the edges of the traversable roadway.

- (b) Any portion of a roadway at an intersection or elsewhere that is distinctly indicated for pedestrian crossing by lines or other markings on the surface.

“**Intersection**” means the area embraced within the prolongation or connection of the lateral curb lines, or if none, the lateral boundary lines of the roadways of two highways that join one another at, or approximately at, right angles, or the area within which vehicles traveling on different highways joining at any other angle may come in conflict. If a highway includes two roadways thirty or more feet apart, each crossing of each roadway of the divided highway by an intersecting highway is a separate intersection. If the intersecting highway also includes two roadways thirty or more feet apart, each crossing of two roadways of the highways is a separate intersection.

“**Motorized wheelchair**” means any self-propelled wheelchair that is used by a person for mobility.

“**Roadway**” means that portion of a highway that is improved, designed or ordinarily used for vehicular travel, exclusive of the berm or shoulder. If a highway includes two or more separate roadways, roadway refers to any such roadway separately but not to all such roadways collectively.

“**Sidewalk**” means that portion of a street that is between the curb lines or the lateral lines of a roadway and the adjacent property lines and that is intended for the use of pedestrians.

“**Traffic**” means pedestrians, ridden or herded animals, vehicles and other conveyances either singly or together while using a highway for purposes of travel.

28-646. Pedestrian control signals; loitering prohibited

- (a) If special pedestrian control signals exhibiting the words “walk” or “don’t walk” are in place, the signals shall indicate as follows:
1. **Walk.** Pedestrians facing the signal may proceed across the roadway in the direction of the signal and shall be given the right-of-way by the drivers of vehicles.
 2. **Don’t walk.** A pedestrian shall not start to cross the roadway in the direction of the signal, but a pedestrian who has partially completed crossing on the walk signal shall proceed to a sidewalk or safety island while the don’t walk signal is showing.
- (b) A pedestrian shall not loiter or unduly delay crossing the roadway after traffic has stopped to give the right-of-way.

28-791. Pedestrians subject to traffic rules

- (a) Pedestrians are subject to traffic control signals at intersections as provided in section 28-645 unless required by local ordinance to comply strictly with the signals. At all places other than intersections, pedestrians are accorded the privileges and are subject to the restrictions stated in this article.
- (b) A local authority may require by ordinance that pedestrians strictly comply with the directions of an official traffic control signal and may prohibit by ordinance pedestrians from crossing a roadway in a business district or crossing a designated highway except in a crosswalk.

28-792. Right-of-way at crosswalk

- (a) Except as provided in section 28-793, subsection B, if traffic control signals are not in place or are not in operation, the driver of a vehicle shall yield the right-of-way, slowing down or stopping if need be in order to yield, to a pedestrian crossing the roadway within a crosswalk when the pedestrian is on the half of the roadway on which the vehicle is traveling or when the pedestrian is approaching so closely from the opposite half of the roadway as to be in danger. A pedestrian shall not suddenly leave any curb or other place of safety and walk or run into the path of

a vehicle that is so close that it is impossible for the driver to yield.

- (b) If a vehicle is stopped at a marked crosswalk or at an unmarked crosswalk at an intersection to permit a pedestrian to cross the roadway, the driver of another vehicle approaching from the rear shall not overtake and pass the stopped vehicle.

28-793. Crossing at other than crosswalk

- (a) A pedestrian crossing a roadway at any point other than within a marked crosswalk or within an unmarked crosswalk at an intersection shall yield the right-of-way to all vehicles on the roadway.
- (b) A pedestrian crossing a roadway at a point where a pedestrian tunnel or overhead pedestrian crossing has been provided shall yield the right-of-way to all vehicles on the roadway.
- (c) Between adjacent intersections at which traffic control signals are in operation, pedestrians shall not cross at any place except in a marked crosswalk.

28-794. Drivers to exercise due care

Notwithstanding the provisions of this chapter every driver of a vehicle shall:

1. Exercise due care to avoid colliding with any pedestrian on any roadway.
2. Give warning by sounding the horn when necessary.
3. Exercise proper precaution on observing a child or a confused or incapacitated person on a roadway.

28-795. Pedestrians to use right half of crosswalk

Pedestrians shall move expeditiously, when practicable, on the right half of crosswalks.

28-796. Pedestrian on roadways

- (a) If sidewalks are provided, a pedestrian shall not walk along and on an adjacent roadway.
- (b) If sidewalks are not provided, a pedestrian walking along and on a highway shall walk when practicable only on the left side of the roadway or its shoulder facing traffic that may approach from the opposite direction.
- (c) A person shall not stand in a roadway for the purpose of soliciting a ride from the driver of a vehicle.

28-856. Emerging from alley, driveway or building

The driver of a vehicle emerging from an alley, driveway or building within a business or residence district shall:

1. Stop the vehicle immediately before driving onto a sidewalk or onto the sidewalk area extending across any alleyway or private driveway.
2. Yield the right-of-way to any pedestrian as necessary to avoid collision.
3. On entering the roadway, yield the right-of-way to all closely approaching vehicles on the roadway.

28-904. Driving on sidewalk

- (a) A person shall not drive a vehicle on a sidewalk area except on a permanent or duly authorized temporary driveway.
- (b) This section does not apply to a motorized wheelchair, electric personal assistive mobility device, authorized emergency vehicle, security vehicle owned by this state or small service vehicle owned by this state or a political subdivision of this state.

28-908. Persons in wheelchairs or on electric personal assistive mobility devices

A person operating a wheelchair or motorized wheelchair or an electric personal assistive mobility device has all of the rights and duties that are contained in this chapter and chapters 4 and 5 of this title and that are applicable to pedestrians except provisions that by their nature can have no application.

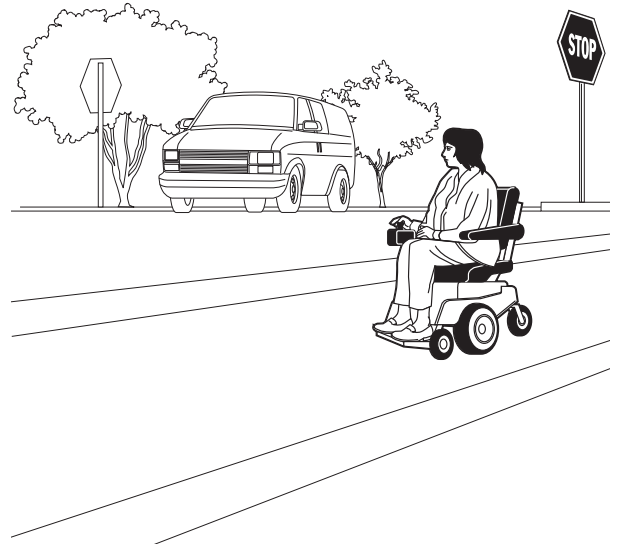

Useful Contact Information

Report roadway maintenance needs on State highways to the appropriate ADOT District.

Contact information for each district is at:
www.azdot.gov/business/district-contacts

You can contact the ADOT Bicycle/Pedestrian Coordinator at: azbikeped@azdot.gov

Notes and Numbers



**Arizona Department of Transportation
Bicycle and Pedestrian Program**

Mail Drop 310B
206 S. 17th Ave., Phoenix, AZ 85007
(602) 712-8141

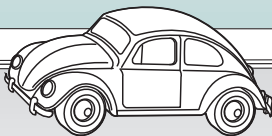

www.azbikeped.org

© 2014 Arizona Department of Transportation.

Created by the Pima County Bicycle and Pedestrian Program,
Matthew Zoll, Program Manager.

Design and illustration by David Burnham, Pima County Graphic Services